

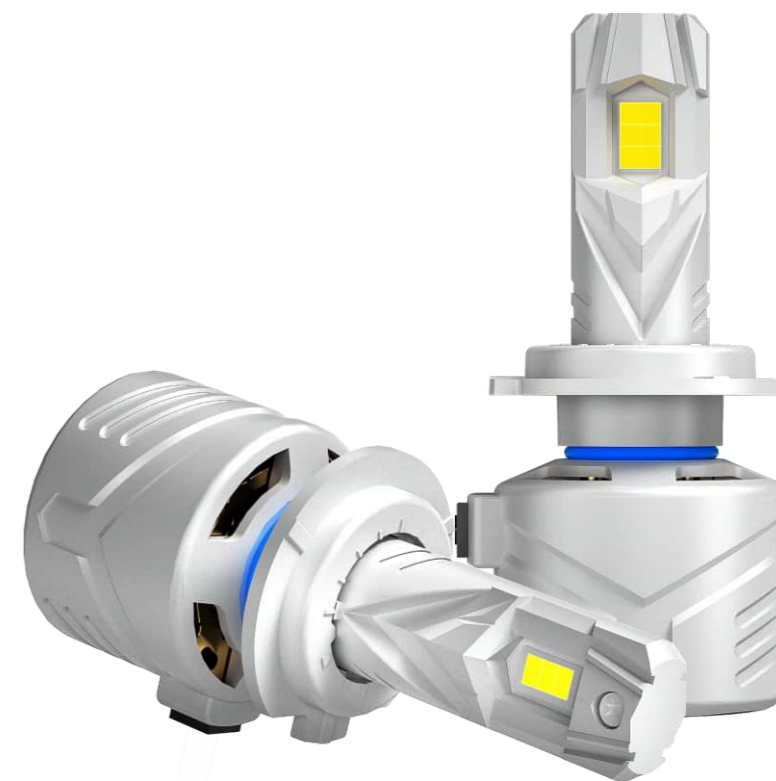

NSSC GROUP

PROFESSIONAL AUTO LED LIGHTING



Guangzhou North and South Lighting Technology Co.,Ltd

Add:7th Bldg., No.68 Hongmian Ave.,Huadu,Guangzhou

Web: www.nssclighting.com

<http://nssclighting.com>

CATALOG REFERENCE



ABOUT NSSC-----Pag 01~04

PLUG&PLAY SERIES LED HEADLIGHT (X9,FH,NH,DX)-----Pag 05~12

EXTERNAL DECODER SERIES LED HEADLIGHT (Z9,Z3,Z6,K2)-----Pag 13~20

MINI LENS SERIES LED HEADLIGHT(Z6L19,NL19)-----Pag 21~24

SUPER LED BULBS -----Pag 25~40

“LIGHT FOR EVERYWHERE”SLIM LED BAR-----Pag 41~42

LED PROJECTOR LENS LIGHT-----Pag 43~46

LED WORK LIGHT&LIGHT BAR-----Pag 47~48

BMW LED MARKER-----Pag 49~50

DAYTIME RUNNING LIGHT-----Pag 51~52

UNIVERSAL LED CAR HEADLIGHT ADAPTER-----Pag 53~54



EXTERNAL DECODER
MODEL:Z9



PLUG AND PLAY
MODEL:X9

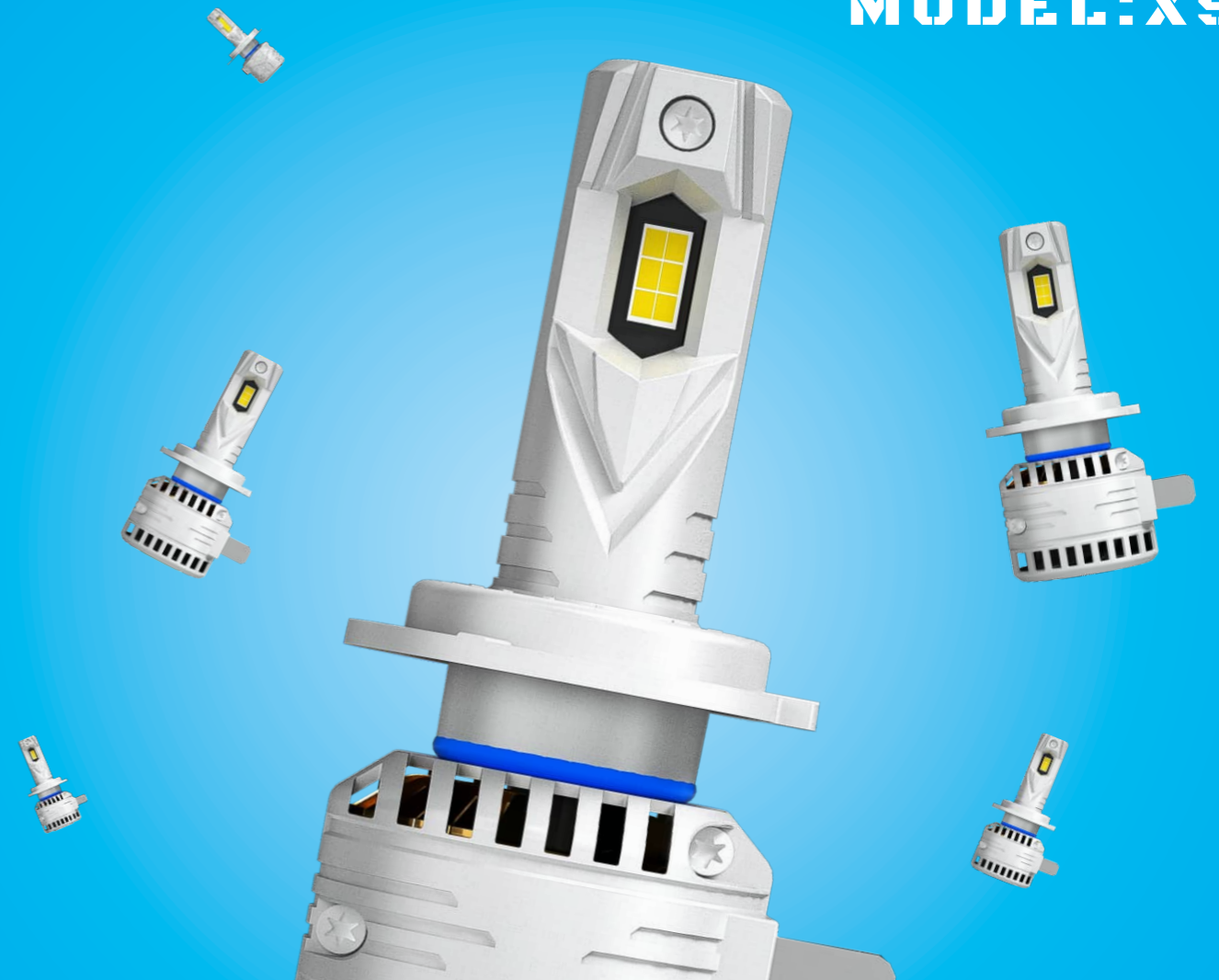

ABOUT NSSC



OVERVIEW

Established in 2006 and located in Guangzhou City, NSSC Group is one of the earliest HID ballast/LED light manufacturer for automotive lighting in China. Our GOAL is to supply the best quality automotive lights with affordable price!



FACILITY & WORKFORCE

NSSC Group has over 86,000 sq. ft. facility with state-of-the-art equipments and seven in-house production lines, There are over 250 experienced workers in production lines and over 30 professional engineers to offer technical guidance and supervision.



GREEN PRODUCTION

As a member of China Environmental Protection Association, NSSC Group strictly implements the related environment protection regulations. All products manufactured here are photobiologically tested and proved up to international standards and safe for human skin and eyes.



MARKETING

NSSC Group has a strong sales team with 32 sales engineers, 12 merchandisers and 8 support staff, they are well experienced, professional and have built up business relationships with hundreds of companies in over 85 countries across the world.

ABOUT NSSC

QUALITY CONTROL

NSSC is ISO9001, IATF16949 & ISO14001 certified and has perfect quality control system, all incoming materials and components will be strictly inspected and tested before used in mass production, all finished products must be entirely inspected and tested to ensure up to all present standards before they are packed for delivery, NSSC will also positively do extra rigorous testing to verify our products' performance under harsh conditions.

Incoming Materials and Components Inspection and Test



Appearance Inspection



LED Chip Inspection



Cable Inspection



Thermostatic Dryer

Finished Products Inspection and Test



Parameter Testing



High-Low Temp Testing



Finished Product Test



Aging Testing

Extra Rigorous Test



Cable Bending Testing



Saline Spray Testing



Vibration Test Machine



Tortured Testing

ABOUT NSSC

PRODUCT EVOLUTION

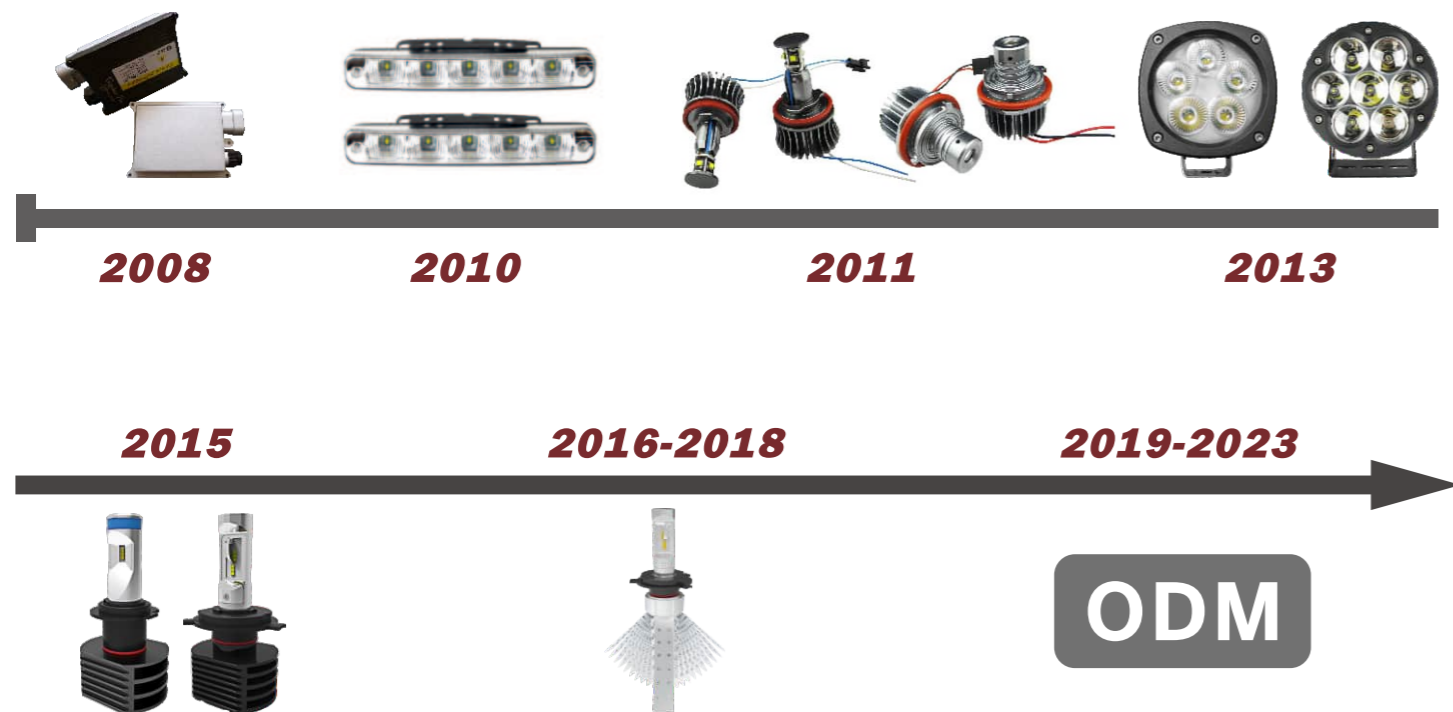

Constant Innovation

- 2008:** China FIRST factory developed CANBUS FREE Ballast
- 2011:** The FIRST factory with Full item of BMW led marker ,with best quality .
- 2013:** Series tough&heavy duty LED light bars 4"-50 " and 4.3",6.5",9.7" led driving lights released,with very best quality ,which called "China Rigid" by US clients .
- 2015:** First fanless design ,with perfect cut-off line headlights released .
- 2016-2018 :** Start to provide in-depth ODM products services to value clients for their own market ,with great sucessful.
- 2019-2023 :** Win great ODM cooperations ,become a solution provider for professional automotive lighting.



ABOUT NSSC

ODM

NSSC has a R&D team with highest professional sense for products "Industrial Design - Optical Design - Structural Design - Circuit Design"
 Since 2015,NSSC start to provide in-depth ODM products services to value clients for their own market ,with great sucessful.

INDUSTRIAL DESIGN & STRUCTURAL DESIGN

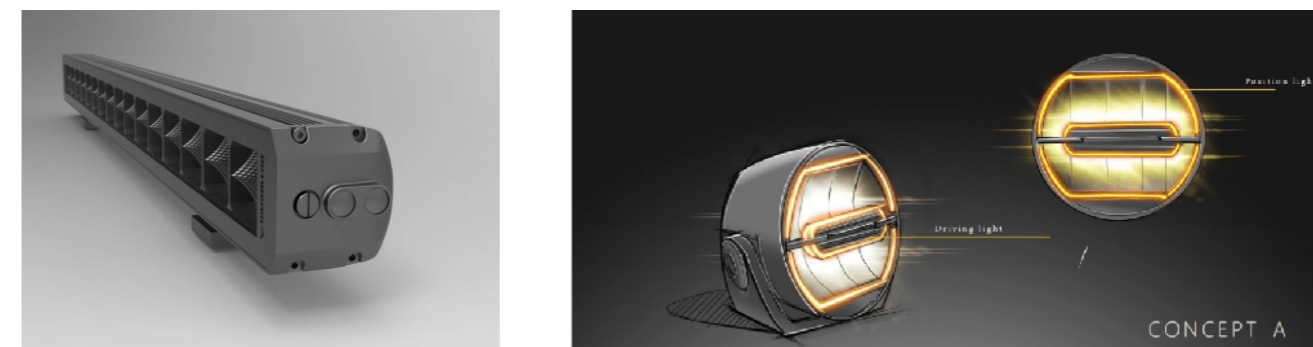

PROFESSIONAL OPTICAL DESIGN



CIRCUIT DESIGN

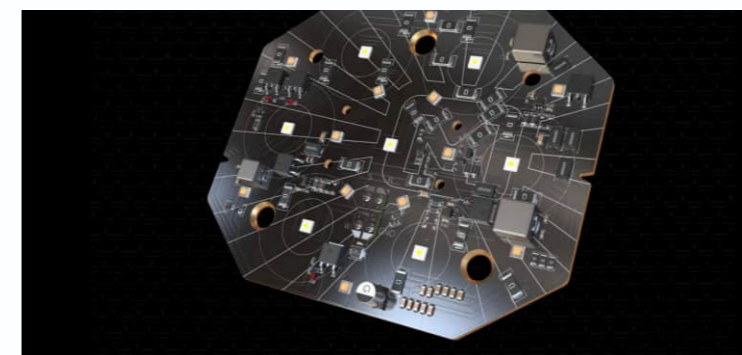

Design performance:650M 1lux long range,60m 1lux wide,meets ECE R149 Ref.40
 Meet the standard of CISPR25 CLASS3

APOLLO LIGHT

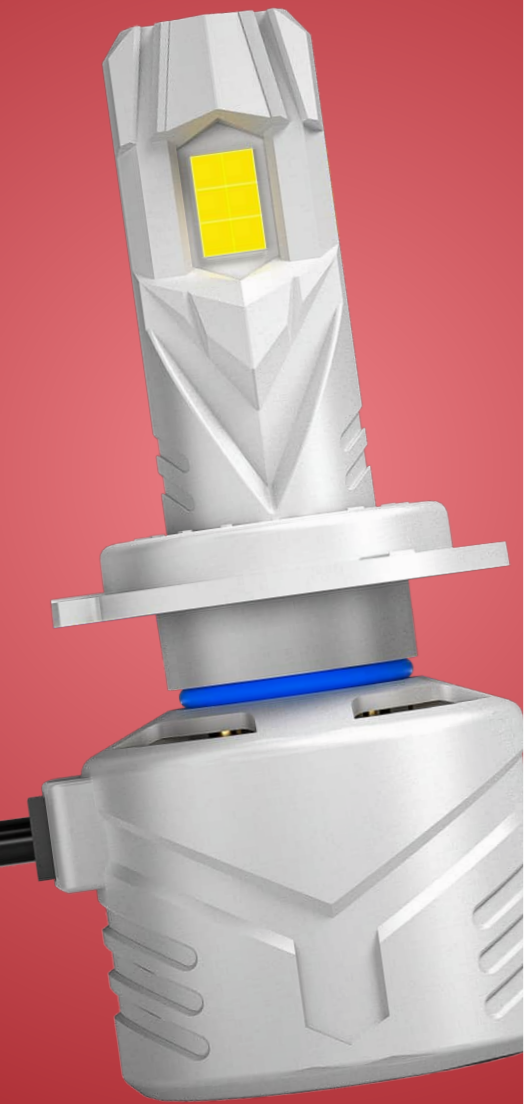

Z9

7000lm

PURE LIGHT



X9

4500lm

BLACK KNIGHT LIGHT



NL19

3000lm

CLASSIC



Z6

2700lm

SEEKER PRO



FH

2500lm

SEEKER



NH

1200lm

X9 LED HEADLIGHTING



Scan code for products details



INTEGRATED CPU CORE COOLING SYSTEM
(HEAT pipe+FINS+FAN Thermal technology)

Steady Working Power:FULL
48-50 WATT

REAL 1:1 DESIGN AS HALOGEN BULB

500% BRIGHTER FOCUSED BEAM PATTERN

FITS FOR 98% VEHICLES



HEAT PIPE+FINS
10 time heat dissipation area

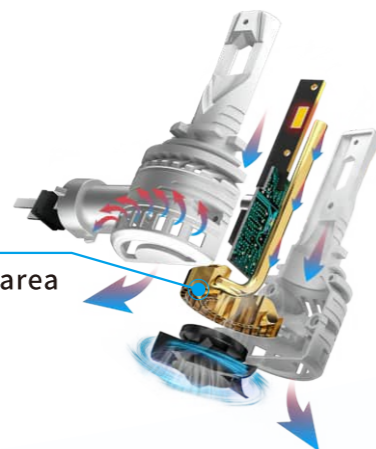

China Patent:
202310801606.4
202321710497.7

US Patent:
18368008

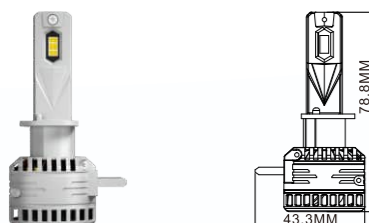

H1

START POWER	STABLE POWER	VOLTAGE	LUMEN	LED CHIP	COLOR TEMPERATURE
52W	45W	DC9-32V	4218lm	6*55mil CSP	6500K

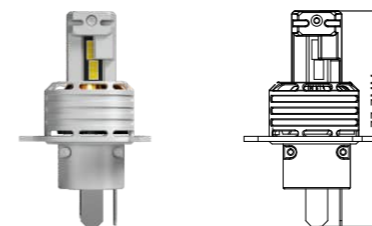

H4

START POWER	STABLE POWER	VOLTAGE	LUMEN	LED CHIP	COLOR TEMPERATURE
53W(hi)/51.8W	48.9W(hi)/48.5W	DC9-32V	4453lm	6*55mil CSP	6500K

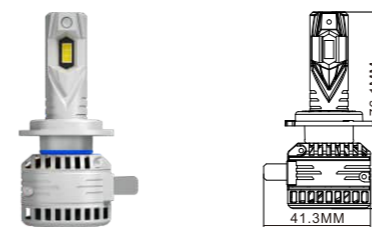

H7

START POWER	STABLE POWER	VOLTAGE	LUMEN	LED CHIP	COLOR TEMPERATURE
55W	48W	DC9-32V	4500lm	6*55mil CSP	6500K

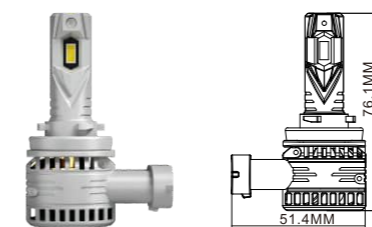

H8/H9/H11

START POWER	STABLE POWER	VOLTAGE	LUMEN	LED CHIP	COLOR TEMPERATURE
53W	48.9W	DC9-32V	4453lm	6*55mil CSP	6500K

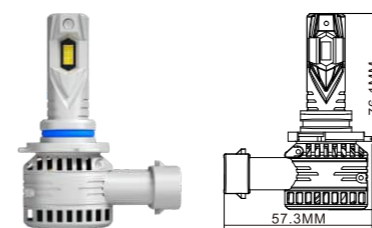

9005/9006/9012

START POWER	STABLE POWER	VOLTAGE	LUMEN	LED CHIP	COLOR TEMPERATURE
55W	49W	DC9-32V	4560lm	6*55mil CSP	6500K

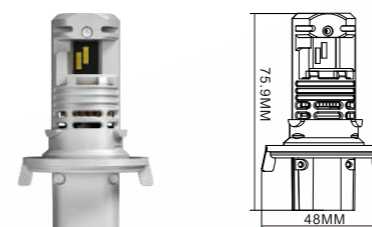

H13

START POWER	STABLE POWER	VOLTAGE	LUMEN	LED CHIP	COLOR TEMPERATURE
52W(hi)/51W	48.9W(hi)/48.5W	DC9-32V	4449lm	6*55mil CSP	6500K

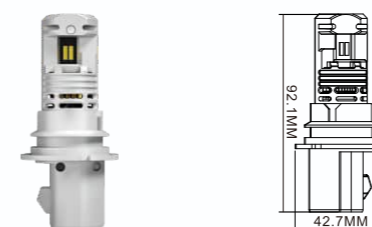

9007

START POWER	STABLE POWER	VOLTAGE	LUMEN	LED CHIP	COLOR TEMPERATURE
53W(hi)/52.5W	49W(hi)/48.7W	DC9-32V	4500lm	6*55mil CSP	6500K

FH LED HEAD LIGHTING



Scan code for products details



FULL WORKING POWER: 22 WATT

1:1 SAME BEAM PATTERN AS HALOGEN BULBS

WIRELESS, PLUG & PLAY INSTALLATION

ULTRA BRIGHTNESS, 300% BRIGHTER THAN HALOGEN

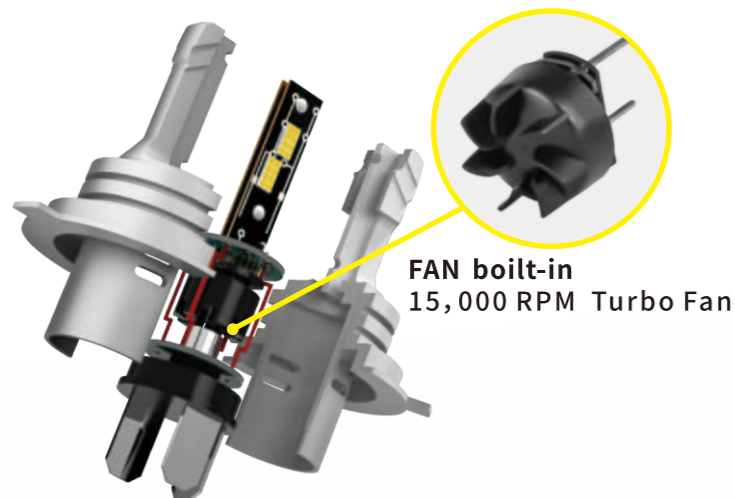

FAN built-in
15,000 RPM Turbo Fan

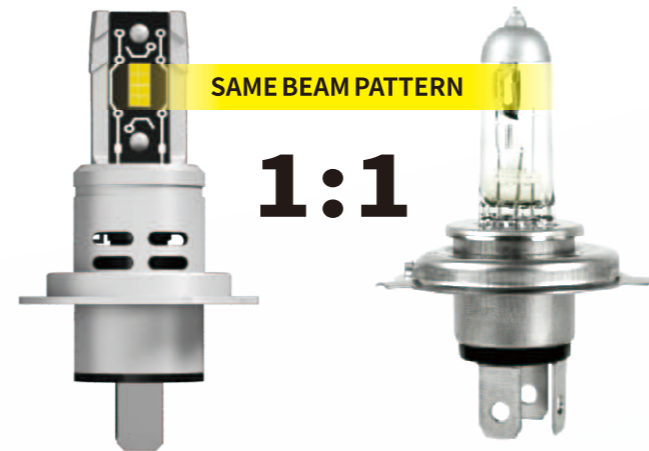

SAME BEAM PATTERN

1:1

5S-FH SERIES

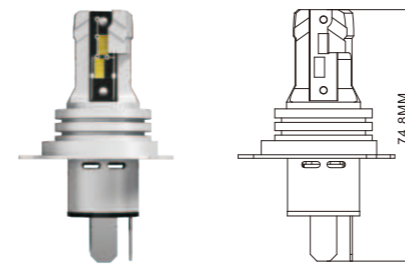

H4

START POWER	START LUMEN	WORKING POWER	WORKING LUMEN	VOLTAGE	LED CHIPS	MATERIAL	COLOR TEMPERATURE
28 (hi) / 26W	2566 / 2383 lm	21.3 (hi) / 20 W	1938 / 1820 lm	12 / 24V	4*3570CSP	Aviation AL6063	6500k

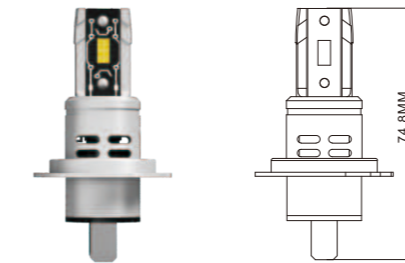

H7

START POWER	START LUMEN	WORKING POWER	WORKING LUMEN	VOLTAGE	LED CHIPS	MATERIAL	COLOR TEMPERATURE
30W	2750lm	22W	1968lm	12/24V	2*3570CSP	Aviation AL6063	6500k

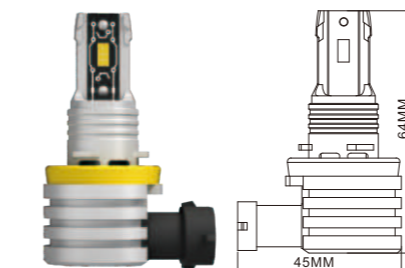

H8/H9/H11

START POWER	START LUMEN	WORKING POWER	WORKING LUMEN	VOLTAGE	LED CHIPS	MATERIAL	COLOR TEMPERATURE
30W	2750lm	22W	1968lm	12/24V	2*3570CSP	Aviation AL6063	6500k

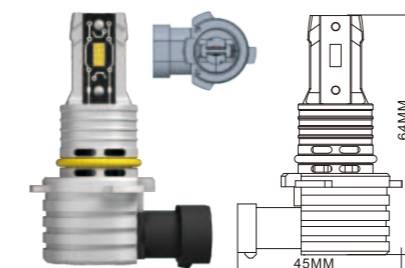

9005

START POWER	START LUMEN	WORKING POWER	WORKING LUMEN	VOLTAGE	LED CHIPS	MATERIAL	COLOR TEMPERATURE
30W	2750lm	22.7W	2080lm	12/24V	2*3570CSP	Aviation AL6063	6500k

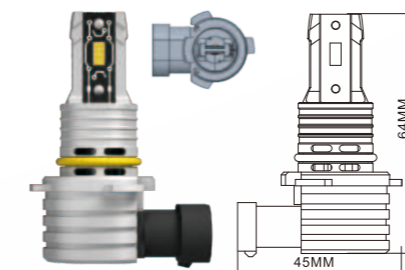

9006

START POWER	START LUMEN	WORKING POWER	WORKING LUMEN	VOLTAGE	LED CHIPS	MATERIAL	COLOR TEMPERATURE
30W	2750lm	22.7W	1998lm	12/24V	2*3570CSP	Aviation AL6063	6500k

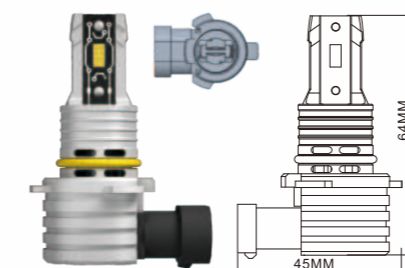

9012

START POWER	START LUMEN	WORKING POWER	WORKING LUMEN	VOLTAGE	LED CHIPS	MATERIAL	COLOR TEMPERATURE
30W	2750lm	22W	1968lm	12/24V	2*3570CSP	Aviation AL6063	6500k

LED LIGHTING 5S-NH



Scan code for products details



1:1 SAME BEAM PATTERN AS HALOGEN

PLAY&PLUG INSTALLATION

No ADDITIONAL ADAPTER REQUIRED

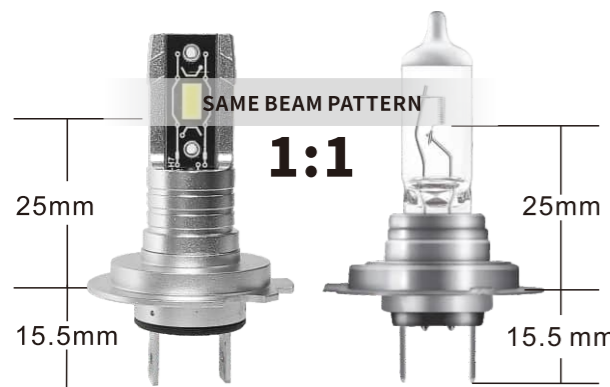

H1 6000K/4000K

POWER	VOLTAGE	LUMEN(LM)	WATER PROOF GRADE	LED CHIPS	MATERIALS
25W	DC9-32V	1986LM	Ip65	2*5530 CSP Chips	Aviation aluminum 6063

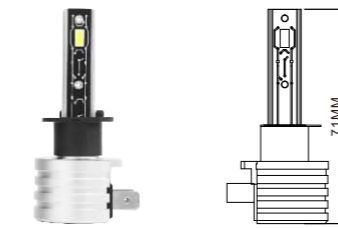
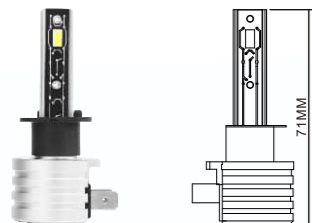

H3 6000K/4000K

POWER	VOLTAGE	LUMEN(LM)	WATER PROOF GRADE	LED CHIPS	MATERIALS
25W	DC9-32V	1986LM	Ip65	2*5530 CSP Chips	Aviation aluminum 6063

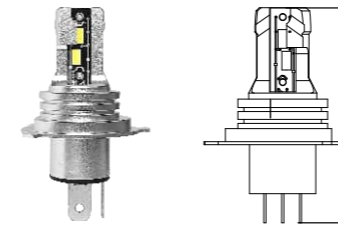

H4 6000K/4000K

POWER	VOLTAGE	LUMEN(LM)	WATER PROOF GRADE	LED CHIPS	MATERIALS
25W	DC9-32V	1986LM	Ip65	4*5530 CSP Chips	Aviation aluminum 6063

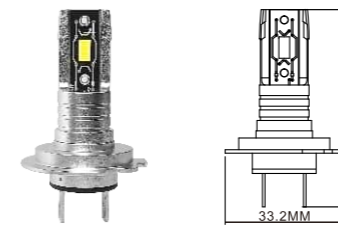

H7 6000K/4000K

POWER	VOLTAGE	LUMEN(LM)	WATER PROOF GRADE	LED CHIPS	MATERIALS
25W	DC9-32V	1986LM	Ip65	2*5530 CSP Chips	Aviation aluminum 6063

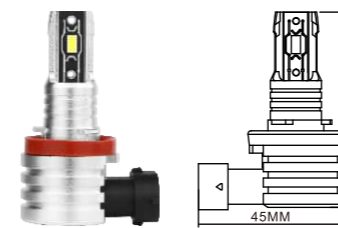

H8/H9/H11 6000K/4000K

POWER	VOLTAGE	LUMEN(LM)	WATER PROOF GRADE	LED CHIPS	MATERIALS
25W	DC9-32V	1986LM	Ip65	2*5530 CSP Chips	Aviation aluminum 6063

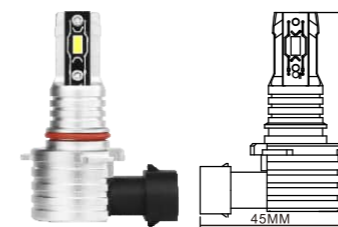

9005 6000K/4000K

POWER	VOLTAGE	LUMEN(LM)	WATER PROOF GRADE	LED CHIPS	MATERIALS
25W	DC9-32V	1986LM	Ip65	2*5530 CSP Chips	Aviation aluminum 6063

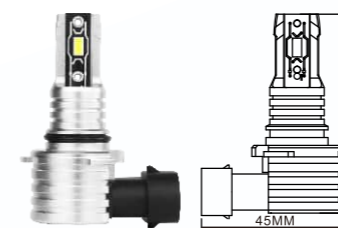

9006 6000K/4000K

POWER	VOLTAGE	LUMEN(LM)	WATER PROOF GRADE	LED CHIPS	MATERIALS
25W	DC9-32V	1986LM	Ip65	2*5530 CSP Chips	Aviation aluminum 6063

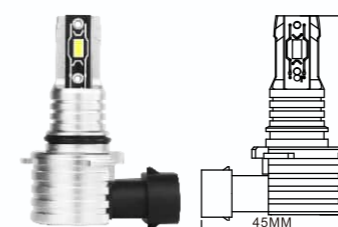

9012 6000K/4000K

POWER	VOLTAGE	LUMEN(LM)	WATER PROOF GRADE	LED CHIPS	MATERIALS
25W	DC9-32V	1986LM	Ip65	2*5530 CSP Chips	Aviation aluminum 6063

LED LIGHTING 5S-D SERIES



Scan code for products details



Cost 50% less



DUAL HEAT PIPE COOLING



PREFECT BEAM PATTERN
Ensure wider and further light area.No glare on coming drivers.



SAME FOCUS
1:1

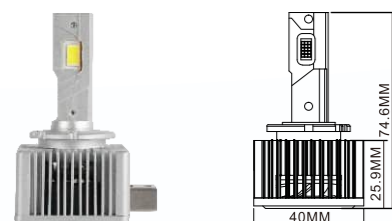

D1C/D1S/D1R

POWER	SUPPLY VOLTAGE	LUMENS	LED CHIPS	COLOR TEMPERATURE	MATERIAL
50W	87V DC	4500lm	2*4575WICOP	6000K	Aviation aluminum 6063

D2C/D2S/D2R

POWER	SUPPLY VOLTAGE	LUMENS	LED CHIPS	COLOR TEMPERATURE	MATERIAL
50W	87V DC	4500lm	2*4575WICOP	6000K	Aviation aluminum 6063

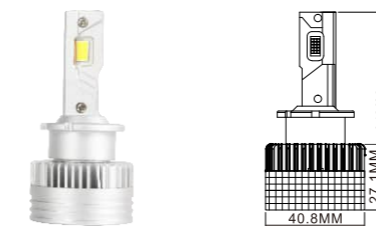

D3C/D3S/D3R

POWER	SUPPLY VOLTAGE	LUMENS	LED CHIPS	COLOR TEMPERATURE	MATERIAL
50W	45V DC	4500lm	2*4575WICOP	6000K	Aviation aluminum 6063

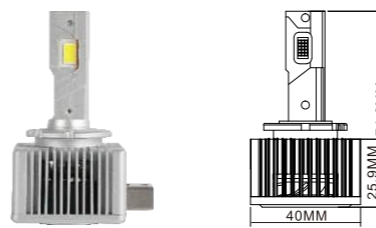

D4C/D4S/D4R

POWER	SUPPLY VOLTAGE	LUMENS	LED CHIPS	COLOR TEMPERATURE	MATERIAL
50W	45V DC	4500lm	2*4575WICOP	6000K	Aviation aluminum 6063



D8S

POWER	SUPPLY VOLTAGE	LUMENS	LED CHIPS	COLOR TEMPERATURE	MATERIAL
50W	45V DC	4500lm	2*4575WICOP	6000K	Aviation aluminum 6063

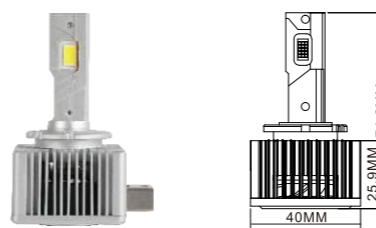

D5S

POWER	SUPPLY VOLTAGE	LUMENS	LED CHIPS	COLOR TEMPERATURE	MATERIAL
50W	12/24V	4500lm	2*3570WICOP	6000K	Aviation aluminum 6063

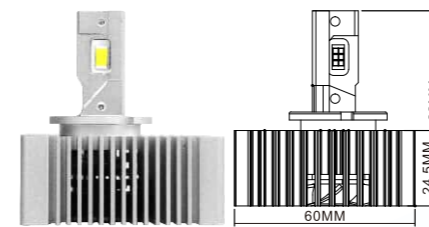

D1K

NEW D1K 12/24V LED Headlight bulb
NSSC D1K lamps = ballasts+hid bulbs

POWER	SUPPLY VOLTAGE	LUMENS	LED CHIPS	COLOR TEMPERATURE	MATERIAL
50W	12/24V	4500lm	2*4575WICOP	6000K	Aviation aluminum 6063

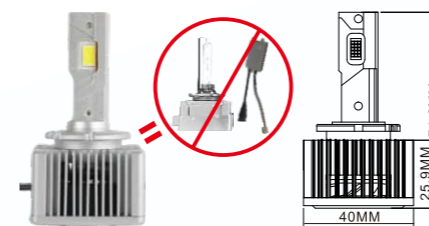

D2K

NEW D2K 12/24V LED Headlight bulb
NSSC D2K lamps = ballasts+hid bulbs

POWER	SUPPLY VOLTAGE	LUMENS	LED CHIPS	COLOR TEMPERATURE	MATERIAL
50W	12/24V	4500lm	2*4575WICOP	6000K	Aviation aluminum 6063



Z9 LED HEAD LIGHTING



Scan code for products details



INTEGRATED CPU CORE COOLING SYSTEM
(Double heat pipe+double FINS+Fan Thermal technology)

REAL working power:80 watt

800% ultra brighter than halogens

1:1 beam pattern as halogen

Built -in Canbus functions ,ERROR free,flicker free

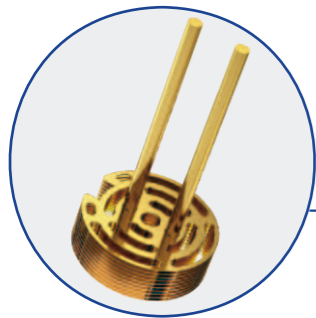

HEAT PIPE+FINS

10 time heat dissipation area

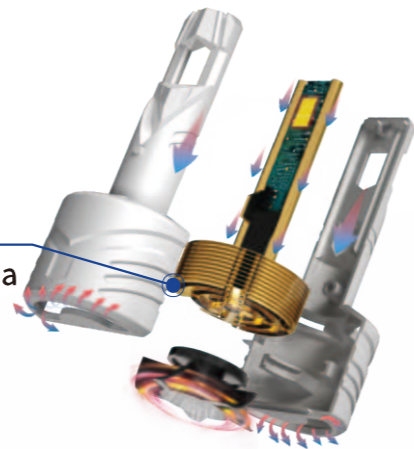

China Patent:
202310801606.4
202321710497.7

US Patent:
18368008

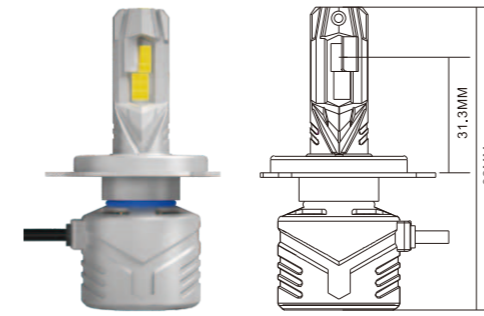

Z9-H4

POWER	VOLTAGE	LUMEN	LED CHIPS	COLOR TEMPERATURE
80W	9-32V	6730(hi)/6820(lo)lm	6*55 mil CSP	6500k

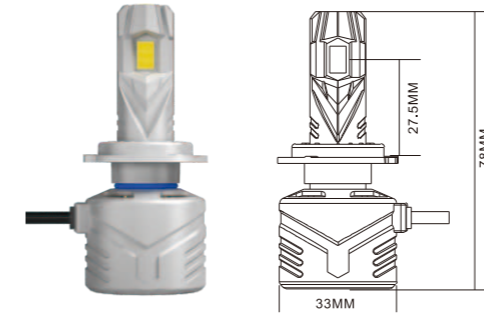

Z9-H7

POWER	VOLTAGE	LUMEN	LED CHIPS	COLOR TEMPERATURE
80W	9-32V	7003lm	6*55 mil CSP	6500k

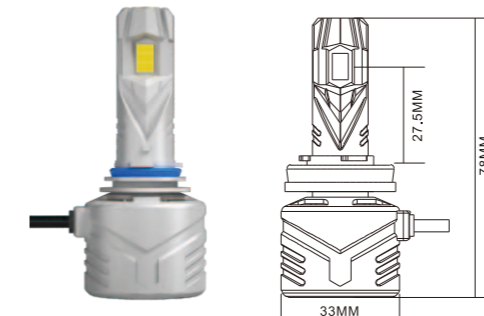

Z9-H8/H9/H11

POWER	VOLTAGE	LUMEN	LED CHIPS	COLOR TEMPERATURE
80W	9-32V	7109lm	6*55 mil CSP	6500k

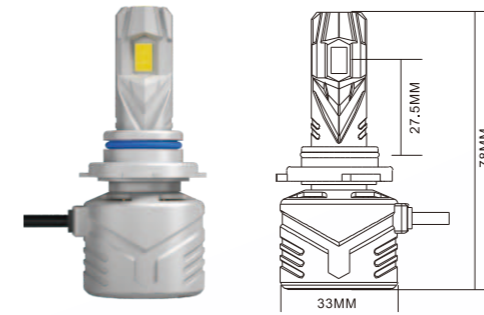

Z9-9005

POWER	VOLTAGE	LUMEN	LED CHIPS	COLOR TEMPERATURE
80W	9-32V	7098lm	6*55 mil CSP	6500k

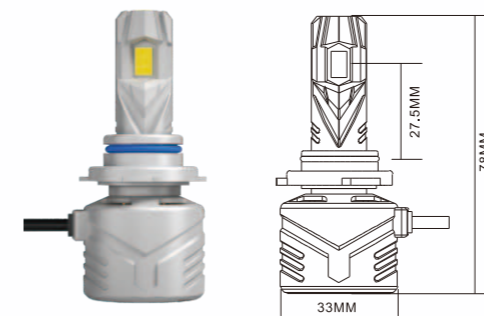

Z9-9006

POWER	VOLTAGE	LUMEN	LED CHIPS	COLOR TEMPERATURE
80W	9-32V	7076lm	6*55 mil CSP	6500k



LED LIGHTING 5S-Z3



Scan code for products details



DUAL HEAT PIPE COOLING

STABLE AT 50W, 4200lm after 2 hrs aging

Non-polarity

Wide range 9-48V, for car & truck & motor

Heat pipe--300 Times heat conduction than copper

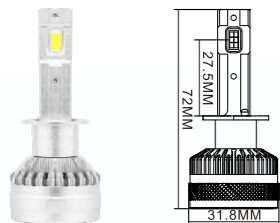
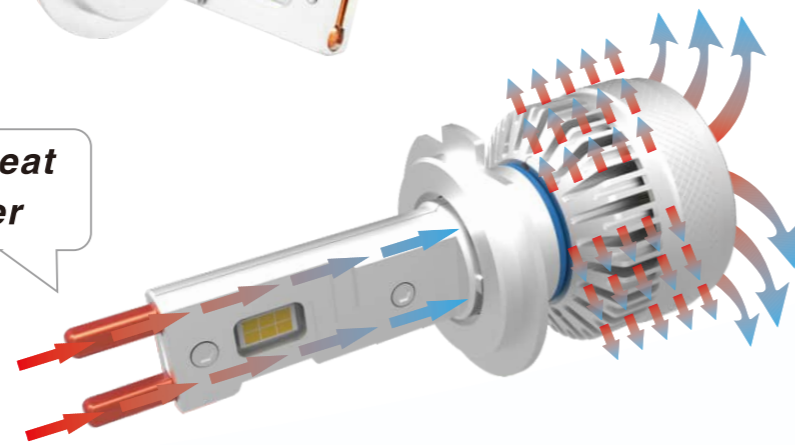

H1 4000K/6000K

START POWER	STABLE POWER	VOLTAGE	STABLE LUMENS	LED CHIPS	MATERIAL
55W	50W	DC9-48V	4469LM	6*55mil CSP	Aviation aluminum 6063

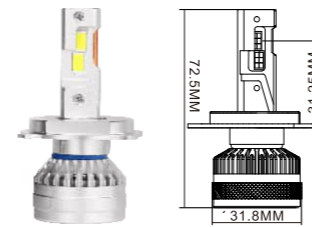

H4 4000K/6000K

START POWER	STABLE POWER	VOLTAGE	STABLE LUMENS	LED CHIPS	MATERIAL
55W	50W	DC9-48V	4476LM	6*55mil CSP	Aviation aluminum 6063

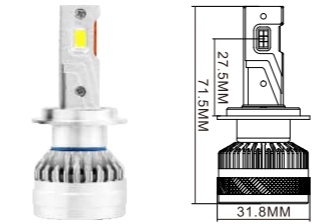

H7 4000K/6000K

START POWER	STABLE POWER	VOLTAGE	STABLE LUMENS	LED CHIPS	MATERIAL
55W	50W	DC9-48V	4512LM	6*55mil CSP	Aviation aluminum 6063

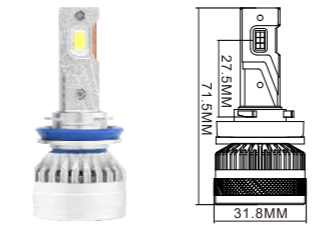

H8/H9/H11 4000K/6000K

START POWER	STABLE POWER	VOLTAGE	STABLE LUMENS	LED CHIPS	MATERIAL
55W	50W	DC9-48V	4542LM	6*55mil CSP	Aviation aluminum 6063

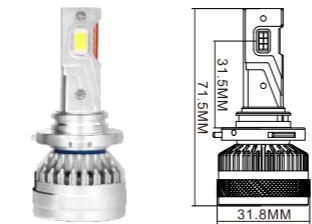

9005 4000K/6000K

START POWER	STABLE POWER	VOLTAGE	STABLE LUMENS	LED CHIPS	MATERIAL
55W	50W	DC9-48V	4599LM	6*55mil CSP	Aviation aluminum 6063

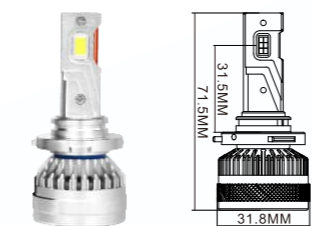

9006 4000K/6000K

START POWER	STABLE POWER	VOLTAGE	STABLE LUMENS	LED CHIPS	MATERIAL
55W	50W	DC9-48V	4599LM	6*55mil CSP	Aviation aluminum 6063

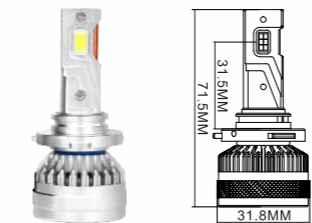

9012 4000K/6000K

START POWER	STABLE POWER	VOLTAGE	STABLE LUMENS	LED CHIPS	MATERIAL
55W	50W	DC9-48V	4599LM	6*55mil CSP	Aviation aluminum 6063



Z6 LED HEAD LIGHTING



Scan code for products details



Fanless for long lifespan

Steady quality ,lowest defective rate

Instantly activate to maximum brightness and with perfect cut-off line beam ,for safer driving

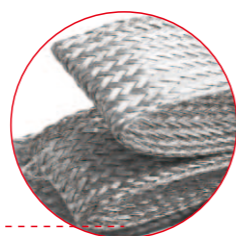

6 pcs 180mm flexible copper belts ,for bigger heatsink area

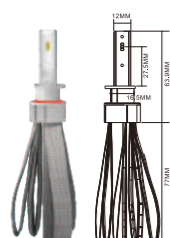

Z6-H1

START POWER	START LUMEN	WORKING POWER	WORKING LUMEN	LED CHIPS	MATERIALS	COLOR TEMPERATURE
21.6W	1922.4lm	19.9W	1751lm	1860CSP	AL6063+pure copper flexible weave cloth heat-sink	6500k

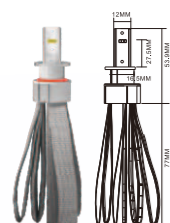

Z6-H3

START POWER	START LUMEN	WORKING POWER	WORKING LUMEN	LED CHIPS	MATERIALS	COLOR TEMPERATURE
20.6W	1890.4lm	18.9W	1701lm	1860CSP	AL6063+pure copper flexible weave cloth heat-sink	6500k

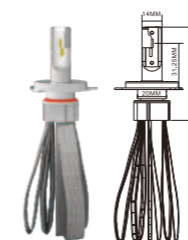

Z6-H4

START POWER	START LUMEN	WORKING POWER	WORKING LUMEN	LED CHIPS	MATERIALS	COLOR TEMPERATURE
23.6 (hi) /22.8W	2023 (hi) 1957lm (lo)	21.5(hi)/20W	1838 (hi) /1739lm (lo)	1860CSP	AL6063+pure copper flexible weave cloth heat-sink	6500k



Z6-H7

START POWER	START LUMEN	WORKING POWER	WORKING LUMEN	LED CHIPS	MATERIALS	COLOR TEMPERATURE
25W	2105lm	20W	1838lm	1860CSP	AL6063+pure copper flexible weave cloth heat-sink	6500k

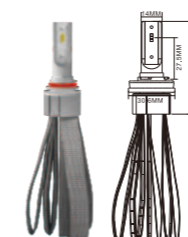

Z6-H8/H9/H11

START POWER	START LUMEN	WORKING POWER	WORKING LUMEN	LED CHIPS	MATERIALS	COLOR TEMPERATURE
24.9W	2099lm	21W	1848lm	1860CSP	AL6063+pure copper flexible weave cloth heat-sink	6500k

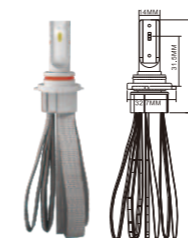

Z6-9005

START POWER	START LUMEN	WORKING POWER	WORKING LUMEN	LED CHIPS	MATERIALS	COLOR TEMPERATURE
24.7W	2182lm	21.1W	1778lm	1860CSP	AL6063+pure copper flexible weave cloth heat-sink	6500k

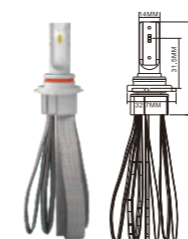

Z6-9006

START POWER	START LUMEN	WORKING POWER	WORKING LUMEN	LED CHIPS	MATERIALS	COLOR TEMPERATURE
25W	2105lm	20W	1838lm	1860CSP	AL6063+pure copper flexible weave cloth heat-sink	6500k

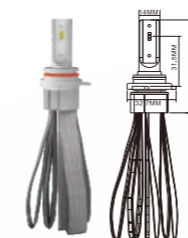

Z6-9012

START POWER	START LUMEN	WORKING POWER	WORKING LUMEN	LED CHIPS	MATERIALS	COLOR TEMPERATURE
25W	2105lm	20W	1838lm	1860CSP	AL6063+pure copper flexible weave cloth heat-sink	6500k

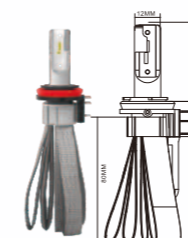

Z6-H15 white +white(DRL) /white+amber(DRL)

START POWER	START LUMEN	WORKING POWER	WORKING LUMEN	LED CHIPS	MATERIALS	COLOR TEMPERATURE
25W	2105lm	20W	1838lm	1860CSP	AL6063+pure copper flexible weave cloth heat-sink	6500k

K2 LED HEADLIGHTING



Scan code for products details



25W Full Power Output

Integrated electronics, no extra drivers

Compact all-in-one design for plug-and-play use

Voltage: 9-32V

Excellent cooling via effective active fan

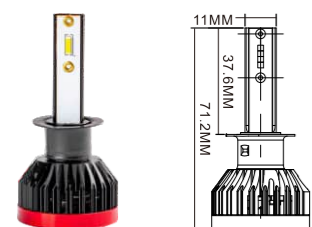

H1

POWER	VOLTAGE	LED CHIPS	MATERIALS	COLOR TEMPERATURE
50W/pair	9-32V	4*1860 csp	6063 aluminum alloy	6000K

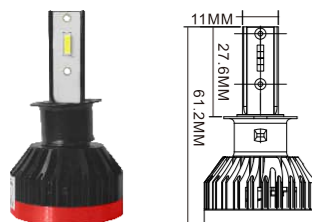

H3

POWER	VOLTAGE	LED CHIPS	MATERIALS	COLOR TEMPERATURE
50W/pair	9-32V	4*1860 csp	6063 aluminum alloy	6000K

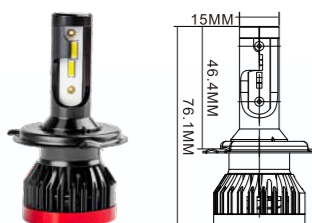

H4

POWER	VOLTAGE	LED CHIPS	MATERIALS	COLOR TEMPERATURE
50W/pair	9-32V	4*1860 csp	6063 aluminum alloy	6000K

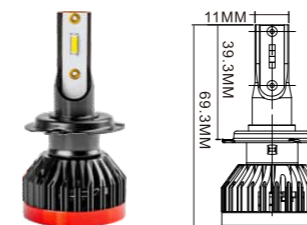

H7

POWER	VOLTAGE	LED CHIPS	MATERIALS	COLOR TEMPERATURE
50W/pair	9-32V	4*1860 csp	6063 aluminum alloy	6000K



H8/H9/H10/H11

POWER	VOLTAGE	LED CHIPS	MATERIALS	COLOR TEMPERATURE
50W/pair	9-32V	4*1860 csp	6063 aluminum alloy	6000K



9005

POWER	VOLTAGE	LED CHIPS	MATERIALS	COLOR TEMPERATURE
50W/pair	9-32V	4*1860 csp	6063 aluminum alloy	6000K



9006

POWER	VOLTAGE	LED CHIPS	MATERIALS	COLOR TEMPERATURE
50W/pair	9-32V	4*1860 csp	6063 aluminum alloy	6000K



5202

POWER	VOLTAGE	LED CHIPS	MATERIALS	COLOR TEMPERATURE
50W/pair	9-32V	4*1860 csp	6063 aluminum alloy	6000K



9012

POWER	VOLTAGE	LED CHIPS	MATERIALS	COLOR TEMPERATURE
50W/pair	9-32V	4*1860 csp	6063 aluminum alloy	6000K

LED HEADLIGHT

Z6L19 LED HEAD LIGHTING



Scan code for products details



With perfect High/LOW beam, NO blind on coming cars

SHORTER and with SMALLER DIAMETER LENS, easier to install and suit for 98% cars

CANBUS ,NO ERROR

Fanless6 , pcs 180mm flexible copper belts , for bigger heatsink area , for long lifespan



SMALLER DIAMETER LENS

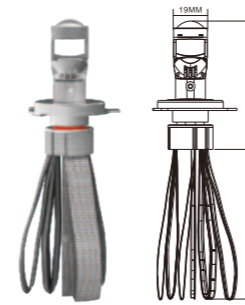
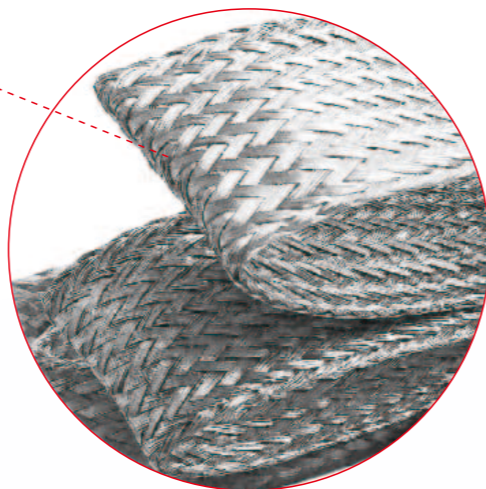

Z6L-H4

POWER	LUMEN	LED CHIPS	LENS DIAMETER	MATERIALS
19.2 (hi)/18.9W	1238lm	3570CSP	19mm	AL6063+pure copper flexible weave cloth heat-sink

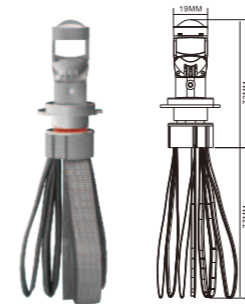

Z6L-H7

POWER	LUMEN	LED CHIPS	LENS DIAMETER	MATERIALS
20W	1300lm	3570CSP	19mm	AL6063+pure copper flexible weave cloth heat-sink

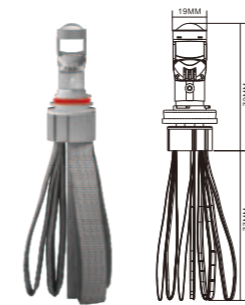

Z6L-H8/H9/H11

POWER	LUMEN	LED CHIPS	LENS DIAMETER	MATERIALS
21W	1380lm	3570CSP	19mm	AL6063+pure copper flexible weave cloth heat-sink

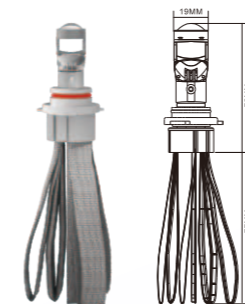

Z6L-9005

POWER	LUMEN	LED CHIPS	LENS DIAMETER	MATERIALS
20.7W	1310lm	3570CSP	19mm	AL6063+pure copper flexible weave cloth heat-sink



Z6L-9006

POWER	LUMEN	LED CHIPS	LENS DIAMETER	MATERIALS
20.7W	1310lm	3570CSP	19mm	AL6063+pure copper flexible weave cloth heat-sink

NL19 LED HEADLIGHTING



Scan code for products details



SAME chips DESIGN as halogen bulb .

With perfect HIGH/LOW BEAM, no blind on coming cars

Ultra-FAST START UP 0.1 second

SHORTER and with SMALLER DIAMETER lens ,easier to install and suit for most cars .

Canbus ,NO error

SMALLER DIAMETER LENS



Perfect HIGH/LOW BEAM

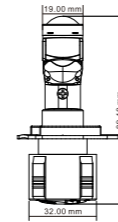

5S-NL-19 H4

START POWER	STEADY POWER	VOLTAGE	LENS DIAMETER	LED CHIPS
30W	27W	9-36V	19mm	3570 WIOP

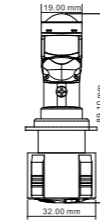

5S-NL-19 H7

START POWER	STEADY POWER	VOLTAGE	LENS DIAMETER	LED CHIPS
30W	27W	9-36V	19mm	3570 WIOP

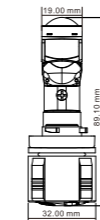

5S-NL-19 H8/H9/H11

START POWER	STEADY POWER	VOLTAGE	LENS DIAMETER	LED CHIPS
30W	27W	9-36V	19mm	3570 WIOP

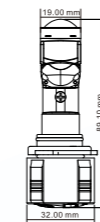

5S-NL-19 9005

START POWER	STEADY POWER	VOLTAGE	LENS DIAMETER	LED CHIPS
30W	27W	9-36V	19mm	3570 WIOP

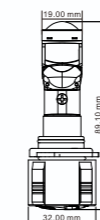

5S-NL-19 9006

START POWER	STEADY POWER	VOLTAGE	LENS DIAMETER	LED CHIPS
30W	27W	9-36V	19mm	3570 WIOP



AUTOMOTIVE LED BULBS



Scan code for products details

PREMIUM Series

Global brand design

Non-polarity

CANBUS

CE

RoHS

LED chips

12V/24V



NS-S5C-T10-W-CAN

MODEL	BASE	COLOR	LED CHIPS	DC	FEATURE
NS-S5C-T10-W-CAN	T10	white	4*3030U chips	12/24V	Constant current; NON-POLARITY; FULL CANBUS,5W



NS-S5C-T15-W-CAN

MODEL	BASE	COLOR	LED CHIPS	DC	FEATURE
NS-S5C-T15-W-CAN	T15	white	4*3030U chips	12/24V	Constant current; NON-POLARITY; FULL CANBUS,5W



NS-S5C-BA9S-W-CAN

MODEL	BASE	COLOR	LED CHIPS	DC	FEATURE
NS-S5C-BA9S-W-CAN	BA9S	white	4*3030U chips	12/24V	Constant current; NON-POLARITY; FULL CANBUS,5W

AUTOMOTIVE LED BULBS



NS-S2C-T10-W

MODEL	BASE	COLOR	LED CHIPS	DC	FEATURE
NS-S2C-T10-W	T10	white	4*3030 chips	12/24V	Constant current; NON-POLARITY; 2W



NS-S2C-T15-W

MODEL	BASE	COLOR	LED CHIPS	DC	FEATURE
NS-S2C-T15-W	T15	white	4*3030 chips	12/24V	Constant current; NON-POLARITY; 2W



NS-S2C-BA9S-W

MODEL	BASE	COLOR	LED CHIPS	DC	FEATURE
NS-S2C-BA9S-W	BA9S	white	4*3030 chips	12/24V	Constant current; NON-POLARITY; 2W



NS-F21-1156-W-CAN

MODEL	BASE	COLOR	LED CHIPS	DC	FEATURE
NS-F21-1156-W-CAN	BA15S/BAU15S	white	2*1860SMD	12/24V	FAN built-in; Constant current; Non-polarity; FULL CANBUS,21W



NS-F21-1157-W-CAN

MODEL	BASE	COLOR	LED CHIPS	DC	FEATURE
NS-F21-1157-W-CAN	BAY15D	white	2*1860SMD	12/24V	FAN built-in; Constant current; Non-polarity; FULL CANBUS,21W



NS-F21-3156-W-CAN

MODEL	BASE	COLOR	LED CHIPS	DC	FEATURE
NS-F21-3156-W-CAN	3156	white	2*1860SMD	12/24V	FAN built-in; Constant current; Non-polarity; FULL CANBUS,21W



NS-F21-3157-W-CAN

MODEL	BASE	COLOR	LED CHIPS	DC	FEATURE
NS-F21-3157-W-CAN	3157	white	2*1860SMD	12/24V	FAN built-in; Constant current; Non-polarity; FULL CANBUS,21W



NS-F21-7440-W-CAN

MODEL	BASE	COLOR	LED CHIPS	DC	FEATURE	
NS-F21-7440-W-CAN	7440	white	2*1860SMD	12/24V	FAN built-in Constant current Non-polarity	FULL CANBUS,21W



NS-F21-7443-W-CAN

MODEL	BASE	COLOR	LED CHIPS	DC	FEATURE	
NS-F21-7443-W-CAN	7443	white	2*1860SMD	12/24V	FAN built-in Constant current Non-polarity	FULL CANBUS,21W



NS-N9-1156-W

MODEL	BASE	COLOR	LED CHIPS	DC	FEATURE	
NS-N9-1156-W	BA15S/BAU15S	white	2*1860SMD	12/24V	Constant current; NON-POLARITY	9W



NS-N9-1157-W

MODEL	BASE	COLOR	LED CHIPS	DC	FEATURE	
NS-N9-1157-W	BAY15D	white	2*1860SMD	12/24V	Constant current; NON-POLARITY	9W+1W



NS-N9-3156-W

MODEL	BASE	COLOR	LED CHIPS	DC	FEATURE	
NS-N9-3156-W	3156	white	2*1860SMD	12/24V	Constant current; NON-POLARITY	9W



NS-N9-3157-W

MODEL	BASE	COLOR	LED CHIPS	DC	FEATURE	
NS-N9-3157-W	3157	white	2*1860SMD	12/24V	Constant current; NON-POLARITY	9W+1W



NS-N9-7440-W

MODEL	BASE	COLOR	LED CHIPS	DC	FEATURE	
NS-N9-7440-W	7440	white	2*1860SMD	12/24V	Constant current; NON-POLARITY	9W



NS-N9-7443-W

MODEL	BASE	COLOR	LED CHIPS	DC	FEATURE	
NS-N9-7443-W	7443	white	2*1860SMD	12/24V	Constant current; NON-POLARITY	9W+1W



NS-N3-1156-W

MODEL	BASE	COLOR	LED CHIPS	DC	FEATURE	
NS-N3-1156-W	BA15S/BAU15S	white	4*3030SMD	12/24V	Constant current; NON-POLARITY	3W



NS-N3-1157-W

MODEL	BASE	COLOR	LED CHIPS	DC	FEATURE	
NS-N3-1157-W	BAY15D	white	4*3030SMD	12/24V	Constant current; NON-POLARITY	3W+0.43W



NS-N3-3156-W

MODEL	BASE	COLOR	LED CHIPS	DC	FEATURE	
NS-N3-3156-W	3156	white	4*3030SMD	12/24V	Constant current; NON-POLARITY	3W



NS-N3-3157-W

MODEL	BASE	COLOR	LED CHIPS	DC	FEATURE	
NS-N3-3157-W	3157	white	4*3030SMD	12/24V	Constant current; NON-POLARITY	3W+0.43W



NS-N3-7440-W

MODEL	BASE	COLOR	LED CHIPS	DC	FEATURE	
NS-N3-7440-W	7440	white	4*3030SMD	12/24V	Constant current; NON-POLARITY	3W



NS-N3-7443-W

MODEL	BASE	COLOR	LED CHIPS	DC	FEATURE	
NS-N3-7443-W	7443	white	4*3030SMD	12/24V	Constant current; NON-POLARITY	3W+0.43W

LED BULB

LED BULB

Ultra Canbus Series



Series type	Metalic	Non-polarity	12/24V	CANBUS	12V
Ultra-U	✓	✓	✓	✓	✓
Super-S	—	✓	✓	✓	✓
Light-L	—	—	—	✓	✓
Classic	—	—	—	—	✓



NS-T10-6SMD-3030-U

MODEL	BASE	COLOR	LED CHIPS	DC	FEATURE
NS-T10-6SMD-3030-U	T10	white	6*3030chips	12V/24V	Constant current; NON-POLARITY; CANBUS

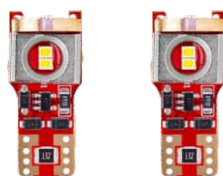

NS-T10-6SMD-2016-U

MODEL	BASE	COLOR	LED CHIPS	DC	FEATURE
NS-T10-6SMD-2016-U	T10	white	6*2016chips	12/24V	Constant current; NON-POLARITY; CANBUS

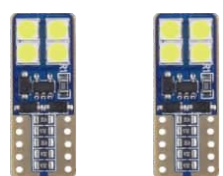

NS-T10-8SMD-2835-U

MODEL	BASE	COLOR	LED CHIPS	DC	FEATURE
NS-T10-8SMD-2835-U	T10	white	8*2835chips	12/24V	Constant current; NON-POLARITY; CANBUS



NS-T10-8SMD-3030-U

MODEL	BASE	COLOR	LED CHIPS	DC	FEATURE
NS-T10-8SMD-3030-U	T10	white	8*3030 chips	12/24V	Constant current; NON-POLARITY; CANBUS



NS-T10-12SMD-2835-U

MODEL	BASE	COLOR	LED CHIPS	DC	FEATURE
NS-T10-12SMD-2835-U	T10	white	12*2835chips	12/24V	Constant current; NON-POLARITY; CANBUS

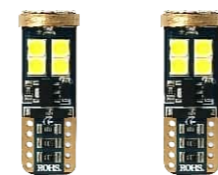

NS-T10-12SMD-3030-U

MODEL	BASE	COLOR	LED CHIPS	DC	FEATURE
NS-T10-12SMD-3030-U	T10	white	12*3030 chips	12/24V	Constant current; NON-POLARITY; CANBUS



NS-T10-18SMD-2016-U

MODEL	BASE	COLOR	LED CHIPS	DC	FEATURE
NS-T10-18SMD-2016-U	T10	white	18*2016chips	12/24V	Constant current; NON-POLARITY; CANBUS



NS-T10-21SMD-2016-U

MODEL	BASE	COLOR	LED CHIPS	DC	FEATURE
NS-T10-21SMD-2016-U	T10	white	21*2016 chips	12V/24V	Constant current; NON-POLARITY; CANBUS



NS-T20/S25-15SMD-3030-U

MODEL	BASE	COLOR	LED CHIPS	DC	FEATURE
NS-T20/S25-15SMD-3030-U	1156/1157/7440/7443/3156/3157	white	15*3030SMD	12/24V	Constant current Non-polarity; CANBUS



NS-T20/S25-24SMD-3020-U

MODEL	BASE	COLOR	LED CHIPS	DC	FEATURE
NS-T20/S25-24SMD-3020-U	1156/1157/7440/7443/3156/3157	white	24*3020SMD	12/24V	Constant current Non-polarity; CANBUS



NS-T20/S25-35SMD-3030-U

MODEL	BASE	COLOR	LED CHIPS	DC	FEATURE
NS-T20/S25-35SMD-3030-U	1156/1157/7440/7443/3156/3157	white	35*3030SMD	12/24V	Constant current Non-polarity; CANBUS

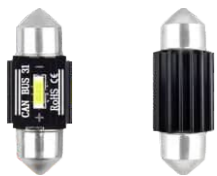

NS-SJ-1SMD-1860-31MM-U

MODEL	BASE	COLOR	LED CHIPS	DC	FEATURE
NS-SJ-1SMD-1860-31MM-U	FESTOON	white	1860	12/24V	Constant Current Without polarity Canbus 31MM



NS-SJ-1SMD-1860-36MM-U

MODEL	BASE	COLOR	LED CHIPS	DC	FEATURE
NS-SJ-1SMD-1860-36MM-U	FESTOON	white	1860	12/24V	Constant Current Without polarity Canbus 36MM



NS-SJ-1SMD-1860-39MM-U

MODEL	BASE	COLOR	LED CHIPS	DC	FEATURE
NS-SJ-1SMD-1860-39MM-U	FESTOON	white	1860	12/24V	Constant Current Without polarity Canbus 39MM



NS-SJ-1SMD-1860-41MM-U

MODEL	BASE	COLOR	LED CHIPS	DC	FEATURE
NS-SJ-1SMD-1860-41MM-U	FESTOON	white	1860	12/24V	Constant Current Without polarity Canbus 41MM

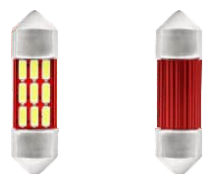

NS-SJ-9SMD-4014-31MM-U

MODEL	BASE	COLOR	LED CHIPS	DC	FEATURE
NS-SJ-9SMD-4014-31MM-U	FESTOON	white	12*4014 chips	12/24V	Constant Current Without polarity Canbus 31MM

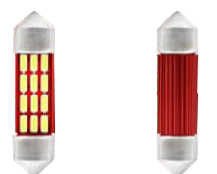

NS-SJ-12SMD-4014-36MM-U

MODEL	BASE	COLOR	LED CHIPS	DC	FEATURE
NS-SJ-12SMD-4014-36MM-U	FESTOON	white	12*4014 chips	12/24V	Constant Current Without polarity Canbus 36MM

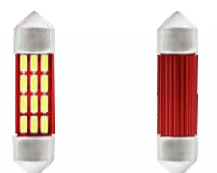

NS-SJ-12SMD-4014-39MM-U

MODEL	BASE	COLOR	LED CHIPS	DC	FEATURE
NS-SJ-12SMD-4014-39MM-U	FESTOON	white	12*4014 chips	12/24V	Constant Current Without polarity Canbus 39MM

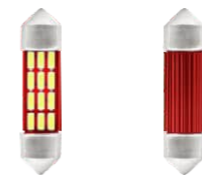

NS-SJ-12SMD-4014-41MM-U

MODEL	BASE	COLOR	LED CHIPS	DC	FEATURE
NS-SJ-12SMD-4014-41MM-U	FESTOON	white	12*4014 chips	12/24V	Constant Current Without polarity Canbus 41MM

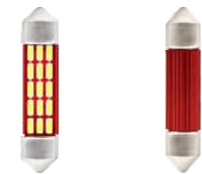

NS-SJ-15SMD-4014-36MM-U

MODEL	BASE	COLOR	LED CHIPS	DC	FEATURE
NS-SJ-15SMD-4014-36MM-U	FESTOON	white	16*4014 chips	12/24V	Constant Current Without polarity Canbus 36MM

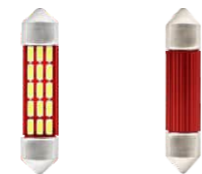

NS-SJ-15SMD-4014-39MM-U

MODEL	BASE	COLOR	LED CHIPS	DC	FEATURE
NS-SJ-15SMD-4014-39MM-U	FESTOON	white	16*4014 chips	12/24V	Constant Current Without polarity Canbus 39MM

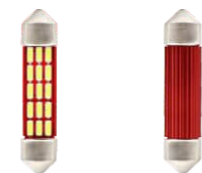

NS-SJ-15SMD-4014-41MM-U

MODEL	BASE	COLOR	LED CHIPS	DC	FEATURE
NS-SJ-15SMD-4014-41MM-U	FESTOON	white	20*4014 chips	12/24V	Constant Current Without polarity Canbus 41MM



NS-SJ-10SMD-4014-31MM-U

MODEL	BASE	COLOR	LED CHIPS	DC	FEATURE
NS-SJ-10SMD-4014-31MM-U	FESTOON	white	10*4014 chips	12/24V	Constant Current Without polarity Canbus 31MM



NS-SJ-10SMD-4014-36MM-U

MODEL	BASE	COLOR	LED CHIPS	DC	FEATURE
NS-SJ-10SMD-4014-36MM-U	FESTOON	white	10*4014 chips	12/24V	Constant Current Without polarity Canbus 36MM



NS-SJ-10SMD-4014-39MM-U

MODEL	BASE	COLOR	LED CHIPS	DC	FEATURE
NS-SJ-10SMD-4014-39MM-U	FESTOON	white	10*4014 chips	12/24V	Constant Current Without polarity Canbus 39MM



NS-SJ-10SMD-4014-41MM-U

MODEL	BASE	COLOR	LED CHIPS	DC	FEATURE
NS-SJ-10SMD-4014-41MM-U	FESTOON	white	10*4014 chips	12/24V	Constant Current Without polarity Canbus 41MM

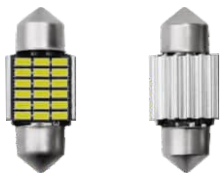

NS-SJ-18SMD-3014-31MM-U

MODEL	BASE	COLOR	LED CHIPS	DC	FEATURE
NS-SJ-18SMD-3014-31MM-U	FESTOON	white	18*3014chips	12/24V	Constant Current Without polarity Canbus 31MM

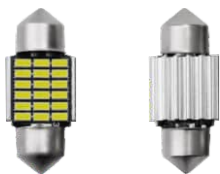

NS-SJ-18SMD-3014-39MM-U

MODEL	BASE	COLOR	LED CHIPS	DC	FEATURE
NS-SJ-18SMD-3014-39MM-U	FESTOON	white	18*3014chips	12/24V	Constant Current Without polarity Canbus 39MM

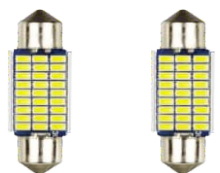

NS-SJ-27SMD-3014-36MM-U

MODEL	BASE	COLOR	LED CHIPS	DC	FEATURE
NS-SJ-27SMD-3014-36MM-U	FESTOON	white	27*3014chips	12/24V	Constant Current Without polarity Canbus 36MM

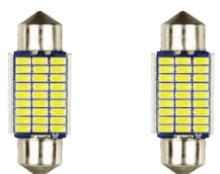

NS-SJ-27SMD-3014-39MM-U

MODEL	BASE	COLOR	LED CHIPS	DC	FEATURE
NS-SJ-27SMD-3014-39MM-U	FESTOON	white	27*3014chips	12/24V	Constant Current Without polarity Canbus 39MM



NS-SJ-30SMD-3014-41MM-U

MODEL	BASE	COLOR	LED CHIPS	DC	FEATURE
NS-SJ-30SMD-3014-41MM-U	FESTOON	white	30*3014chips	12/24V	Constant Current Without polarity Canbus 41MM

Super Canbus Series

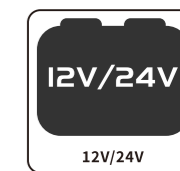
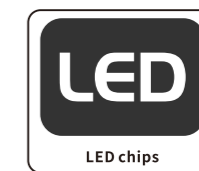
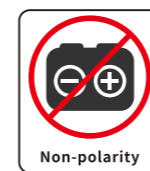

Series type	Metalic	Non-polarity	12/24V	CANBUS	12V
Ultra-U	✓	✓	✓	✓	✓
Super-S	—	✓	✓	✓	✓
Light-L	—	—	—	✓	✓
Classic	—	—	—	—	✓



NS-T10-6SMD-3030-S

MODEL	BASE	COLOR	LED CHIPS	DC	FEATURE
NS-T10-6SMD-3030-S	T10	white	6*3030chips	12V/24V	Constant current; NON-POLARITY CANBUS

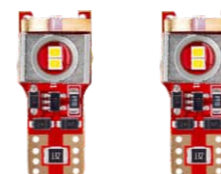

NS-T10-6SMD-2016-S

MODEL	BASE	COLOR	LED CHIPS	DC	FEATURE
NS-T10-6SMD-2016-S	T10	white	6*2016chips	12/24V	Constant current; NON-POLARITY CANBUS

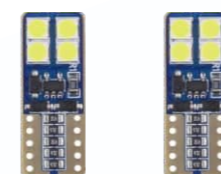

NS-T10-8SMD-2835-S

MODEL	BASE	COLOR	LED CHIPS	DC	FEATURE
NS-T10-8SMD-2835-S	T10	white	8*2835chips	12/24V	Constant current; NON-POLARITY CANBUS

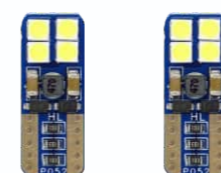

NS-T10-8SMD-3030-S

MODEL	BASE	COLOR	LED CHIPS	DC	FEATURE
NS-T10-8SMD-3030-S	T10	white	8*3030 chips	12/24V	Constant current; NON-POLARITY CANBUS

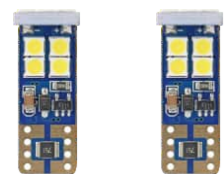

NS-T10-12SMD-2835-S

MODEL	BASE	COLOR	LED CHIPS	DC	FEATURE	
NS-T10-12SMD-2835-S	T10	white	12*2835chips	12/24V	Constant current; NON-POLARITY	CANBUS



NS-T10-12SMD-3030-S

MODEL	BASE	COLOR	LED CHIPS	DC	FEATURE	
NS-T10-12SMD-3030-S	T10	white	12*3030 chips	12/24V	Constant current; NON-POLARITY	CANBUS

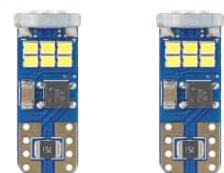

NS-T10-18SMD-2016-S

MODEL	BASE	COLOR	LED CHIPS	DC	FEATURE	
NS-T10-18SMD-2016-S	T10	white	18*2016chips	12/24V	Constant current; NON-POLARITY	CANBUS

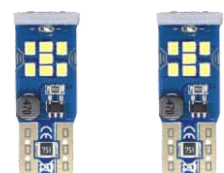

NS-T10-21SMD-2016-S

MODEL	BASE	COLOR	LED CHIPS	DC	FEATURE	
NS-T10-21SMD-2016-S	T10	white	21*2016 chips	12V/24V	Constant current; NON-POLARITY	CANBUS

LED BULB

LED BULB

Light Canbus Series

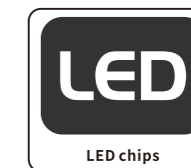

Series type	Metalic	Non-polarity	12/24V	CANBUS	12V
Ultra-U	✓	✓	✓	✓	✓
Super-S	—	✓	✓	✓	✓
Light-L	—	—	—	✓	✓
Classic	—	—	—	—	✓



NS-T10-6SMD-5730-L

MODEL	BASE	COLOR	LED CHIPS	DC	FEATURE	
NS-T10-6SMD-5730-L	T10	white	6*5730chips	12V	normal	CANBUS



NS-T10-6SMD-3030-L

MODEL	BASE	COLOR	LED CHIPS	DC	FEATURE	
NS-T10-6SMD-3030-L	T10	white	6*3030chips	12V	normal	CANBUS

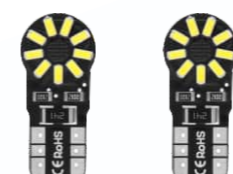

NS-T10-18SMD-3014-L

MODEL	BASE	COLOR	LED CHIPS	DC	FEATURE	
NS-T10-18SMD-3014-L	T10	white	18*3014 chips	12V	normal	CANBUS

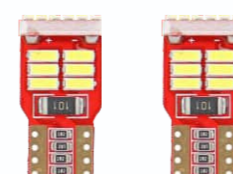

NS-T10-18SMD-4014-L

MODEL	BASE	COLOR	LED CHIPS	DC	FEATURE	
NS-T10-18SMD-4014-L	T10	white	18*4014chips	12V	normal	CANBUS

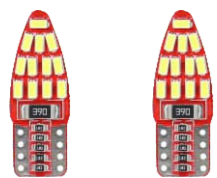

NS-T10-24SMD-3014-L

MODEL	BASE	COLOR	LED CHIPS	DC	FEATURE	
NS-T10-24SMD-3014-L	T10	white	24*3014 chips	12V	normal	CANBUS

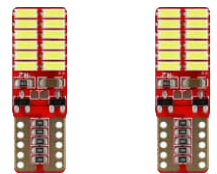

NS-T10-24SMD-4014-L

MODEL	BASE	COLOR	LED CHIPS	DC	FEATURE	
NS-T10-24SMD-4014-L	T10	white	24*4014 chips	12V	normal	CANBUS

LED BULB

LED BULB

Classical Series

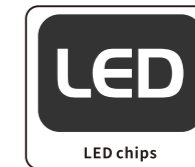

Series type	Metalic	Non-polarity	12/24V	CANBUS	12V
Ultra-U	✓	✓	✓	✓	✓
Super-S	—	✓	✓	✓	✓
Light-L	—	—	—	✓	✓
Classic	—	—	—	—	✓



NS-T10-5SMD-5050-C

MODEL	BASE	COLOR	LED CHIPS	DC	FEATURE	
NS-T10-5SMD-5050-C	T10	white	5*5050chips	12V	normal	normal



NS-SJ-8SMD-5050-31MM-C

MODEL	BASE	COLOR	LED CHIPS	DC	FEATURE	
NS-SJ-8SMD-5050-31mm-C	FESTOON	white	8*5050chips	12V	normal	31MM



NS-SJ-8SMD-5050-36MM-C

MODEL	BASE	COLOR	LED CHIPS	DC	FEATURE	
NS-SJ-8SMD-5050-36mm-C	FESTOON	white	8*5050chips	12V	normal	36MM



NS-SJ-8SMD-5050-39MM-C

MODEL	BASE	COLOR	LED CHIPS	DC	FEATURE	
NS-SJ-8SMD-5050-39mm-C	FESTOON	white	8*5050chips	12V	normal	39MM



NS-SJ-8SMD-5050-41MM-C

MODEL	BASE	COLOR	LED CHIPS	DC	FEATURE	
NS-SJ-8SMD-5050-41mm-C	FESTOON	white	8*5050chips	12V	normal	41MM



NS-T10-9SMD-5050-C

MODEL	BASE	COLOR	LED CHIPS	DC	FEATURE	
NS-T10-9SMD-5050-C	T10	white	9*5050chips	12V	normal	normal



NS-T10-13SMD-5050-C

MODEL	BASE	COLOR	LED CHIPS	DC	FEATURE	
NS-T10-13SMD-5050-C	T10	white	13*5050chips	12V	normal	normal



NS-S25/T20-13SMD-5050-C

MODEL	BASE	COLOR	LED CHIPS	DC	FEATURE	
NS-S25/T20-13SMD-5050-C	1156/1157/7440/7443/3156/3157	white	13*5050chips	12/24V	Constant current Non-polarity	



NS-T10-21SMD-3014-C

MODEL	BASE	COLOR	LED CHIPS	DC	FEATURE	
NS-T10-21SMD-3014-C	T10	white	21*3014 chips	12V	normal	normal

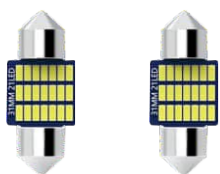

NS-SJ-21SMD-3014-31MM-C

MODEL	BASE	COLOR	LED CHIPS	DC	FEATURE	
NS-SJ-21SMD-3014-31mm-C	FESTOON	white	21*3014 chips	12/24V	normal	31MM

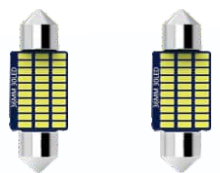

NS-SJ-30SMD-3014-36MM-C

MODEL	BASE	COLOR	LED CHIPS	DC	FEATURE	
NS-SJ-30SMD-3014-36mm-C	FESTOON	white	30*3014 chips	12/24V	normal	36MM

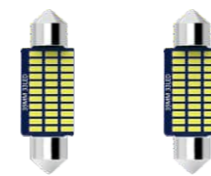

NS-SJ-30SMD-3014-39MM-C

MODEL	BASE	COLOR	LED CHIPS	DC	FEATURE	
NS-SJ-30SMD-3014-39mm-C	FESTOON	white	30*3014 chips	12/24V	normal	39MM

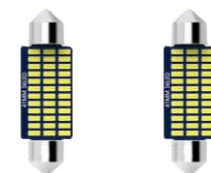

NS-SJ-30SMD-3014-41MM-C

MODEL	BASE	COLOR	LED CHIPS	DC	FEATURE	
NS-SJ-30SMD-3014-41mm-C	FESTOON	white	30*3014 chips	12/24V	normal	41MM

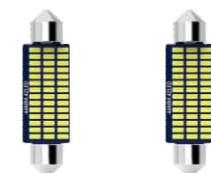

NS-SJ-42SMD-3014-44MM-C

MODEL	BASE	COLOR	LED CHIPS	DC	FEATURE	
NS-SJ-42SMD-3014-44mm-C	FESTOON	white	42*3014 chips	12/24V	normal	44MM

LIGHT FOR EVERYWHERE

If you have metallic, it can be used for everywhere



- Automatic Light Sensor
- Magnetic + sticker installation, NO damage
- wiring-free
- Type-C charging port
- Product materials:ABS +AL6061

Parameter

Length	23cm	30cm	40cm
product size	23*4.1*0.9cm	30*4.1*0.9cm	40*4.1*0.9cm
power	1.2W	1.5W	1.8W
Battery capacity	1100mAh	1500mAh	1500mAh

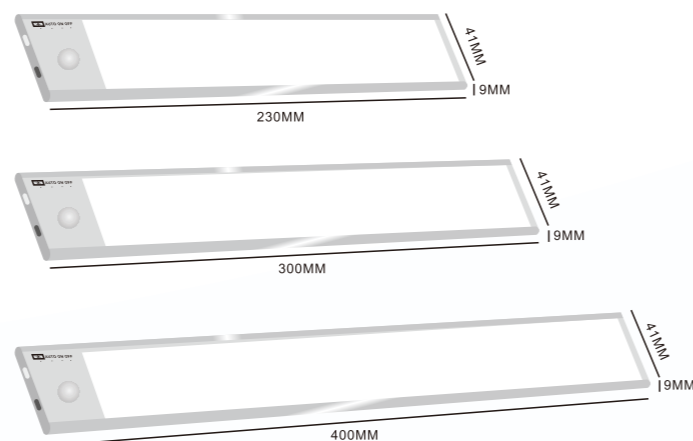

- AUTO** First touch:enter Smart Sensor Mode
- ON** Second touch:always-on mode
- OFF** The third touch:Turn off

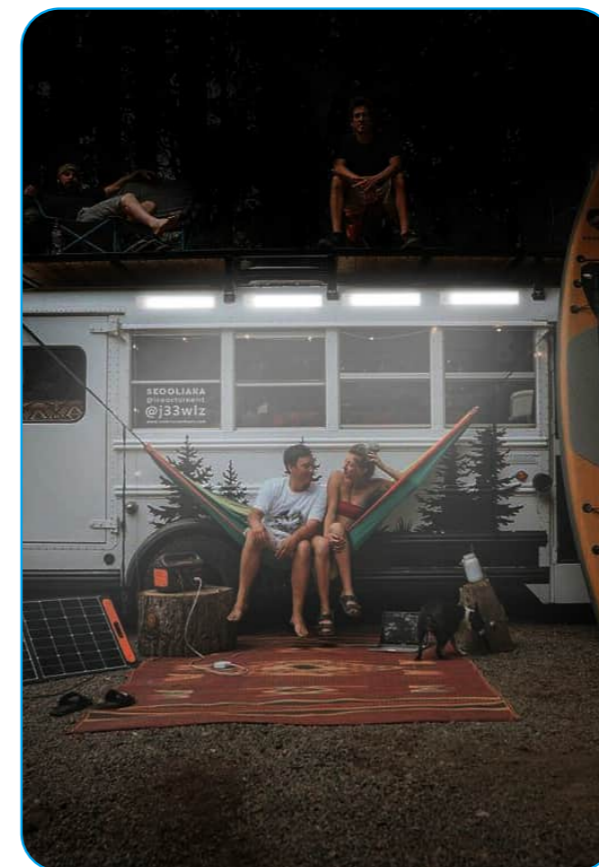

LIGHT FOR EVERYWHERE

LIGHT FOR EVERYWHERE



LED PROJECTOR LENS LIGHT



Scan code for products details



- Available in 1.5 inch, 2.5 inch, 3 inch lens headlight
- High color rendering index, color CRI > 90%
- Maximum brightness in the area of the black-and-white border, NO glare from the near zone.
- Soft driving boundary lines, Not tired after long time driving



NS-PL-14-2.5 (2.5inch)

POWER	LENS SIZE	VOLTAGE	LUMEN	COLOR TEMPERATURE
40W lo/50W hi	2.5Inch	9-16V DC	5900 lo/6700 hi	6000K



NS-PL-02

POWER	LENS SIZE	VOLTAGE	LUMEN	COLOR TEMPERATURE
40W lo/50W hi	3Inch	9-16V DC	6290 lo/7700 hi	6000K

LED PROJECTOR LENS LIGHT



NS-PL-B17 (lens with blue coating glass)

POWER	LENS SIZE	VOLTAGE	LUMEN	COLOR TEMPERATURE
40W lo/50W hi	3Inch	9-16V DC	9890 lo/11000 hi	6000K



NS-BPL-01

POWER	LENS SIZE	VOLTAGE	LUMEN	COLOR TEMPERATURE
50W lo/60W hi	3Inch	9-16V DC	5390 lo/5750 hi	6000K



NS-BPL-03

POWER	LENS SIZE	VOLTAGE	LUMEN	COLOR TEMPERATURE
48W lo/60W hi	3Inch	9-16V DC	4330 lo/6050 hi	6000K



NS-BPL-05

POWER	LENS SIZE	VOLTAGE	LUMEN	COLOR TEMPERATURE
50W lo/60W hi	3Inch	9-16V DC	6100 lo/7000 hi	6000K



NS-BPL-10

POWER	LENS SIZE	VOLTAGE	LUMEN	COLOR TEMPERATURE
42W lo/55W hi	3Inch	9-16V DC	5124 lo/6710 hi	6000K

LED PROJECTOR LENS LIGHT



NS-BPL-11

POWER	LENS SIZE	VOLTAGE	LUMEN	COLOR TEMPERATURE
52W lo/61W hi	3Inch	9-16V DC	6344 lo/7442 hi	6000K



NS-LBPL-04 (BI-LED projector Lens with laser)

POWER	LENS SIZE	VOLTAGE	LUMEN	COLOR TEMPERATURE
45W lo/55W hi	3Inch	9-16V DC	5750 lo/6500 hi	6000K



NS-LBPL-08 (BI-LED projector Lens with laser)

POWER	LENS SIZE	VOLTAGE	LUMEN	COLOR TEMPERATURE
55W lo/65W hi/ 80W hi+laser	3Inch	9-16V DC	6500 lo/6000 hi/ 1230lm hi+laser	6000K



NS-MBPL-07(1.5INCH BI LED Projector Lens)

POWER	LENS SIZE	VOLTAGE	LUMEN	COLOR TEMPERATURE
40W lo/50W hi/	1.5Inch	9-16V DC	5900 lo/6700 hi/	6000K



NS-MBPL-12 (1.5INCH BI-LED projector lens)

POWER	LENS SIZE	VOLTAGE	LUMEN	COLOR TEMPERATURE
40W lo/35W	1.5Inch	9-16V DC	3660 lo/4270 hi	6000K



NS-HPL-13 (High Beam)



POWER	LENS SIZE	VOLTAGE	LUMEN	COLOR TEMPERATURE
30W/PCS	1.5Inch	9-16V DC	3000lm	6000K



NS-HPL-15 (High Beam)



POWER	LENS SIZE	VOLTAGE	LUMEN	COLOR TEMPERATURE
35W/pcs	1.5Inch	9-16V DC	3500lm	6000K



NS-HPL-15L (High Beam)



POWER	LENS SIZE	VOLTAGE	LUMEN	COLOR TEMPERATURE
19W /pcs	1.5Inch	9-16V DC	3500lm	6000K

LED PROJECTOR LENS LIGHT

LED PROJECTOR LENS LIGHT

WORK LIGHT & LIGHT BAR

WORK LIGHT & LIGHT BAR



Scan code for products details

CE RoHS 2002/95/EC E24 -R112,R7,R148,R149



NS-RD-35W

POWER	VOLTAGE	CHIPS	MATERIALS
35W	9-36V	7*5W CREE XT-E	6063AL
WATERPROOF	EMI/RFI	LUMEN	BEAM PATTERNS
Ip68	CISPR25	4340lm	Spot and flood

NS-RD-50W

POWER	VOLTAGE	CHIPS	MATERIALS
50W	9-36V	5*10W CREE XM-L	6063AL
WATERPROOF	EMI/RFI	LUMEN	BEAM PATTERNS
Ip68	CISPR25	7300lm	Spot and flood

NS-RD-O60

POWER	VOLTAGE	CHIPS	MATERIALS
60W	9-36V	6*10W CREE XM-L	6063AL
WATERPROOF	EMI/RFI	LUMEN	BEAM PATTERNS
Ip68	CISPR25	8760lm	Spot (perfect beam)

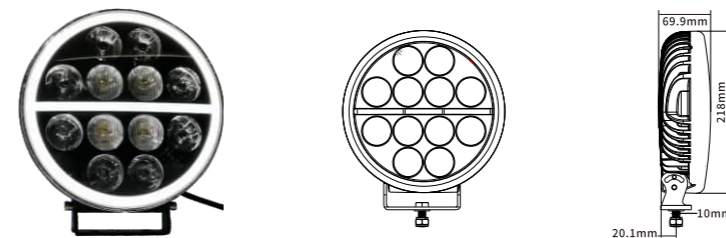
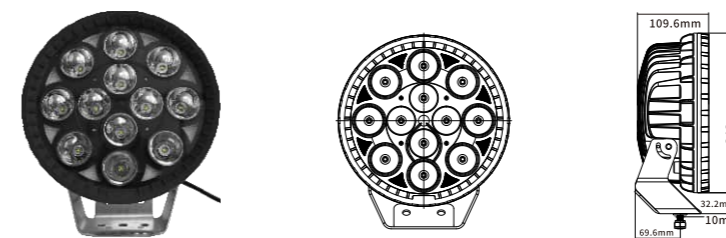
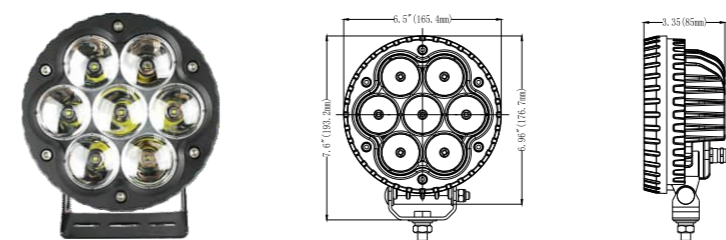
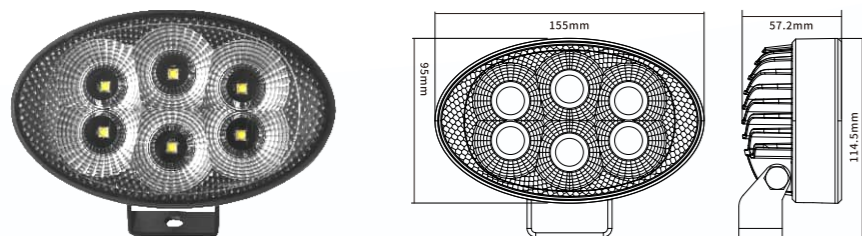
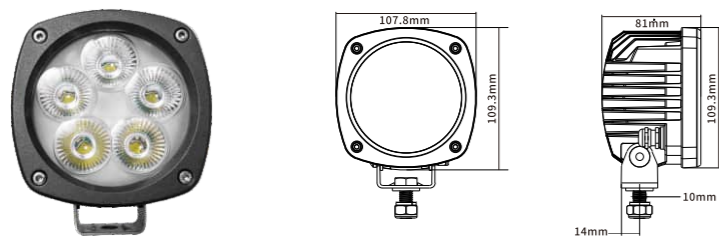
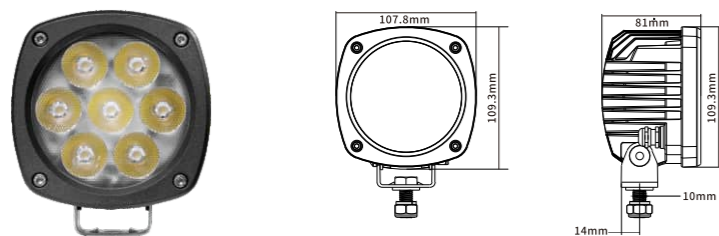

NS-RD-70W

POWER	VOLTAGE	CHIPS	MATERIALS
70W	9-36V	7*10W CREE XM-L	6063AL
WATERPROOF	EMI/RFI	LUMEN	BEAM PATTERNS
Ip68	CISPR25	10220lm	Spot, flood and combo

NS-RD-120W

POWER	VOLTAGE	CHIPS	MATERIALS
120W	9-36V	12*10W CREE XM-L	6063AL
WATERPROOF	EMI/RFI	LUMEN	BEAM PATTERNS
Ip68	CISPR25	17520lm	Spot and flood

NS-RD-180W

POWER	VOLTAGE	CHIPS	MATERIALS
180W	9-36V	18*10W CREE XM-L	6063AL
WATERPROOF	EMI/RFI	LUMEN	BEAM PATTERNS
Ip68	CISPR25	26280lm	Spot

MAX 180W, 740lm 1lux, dual color (white&red) parking light.

NS-WL-1R20

POWER	VOLTAGE	CHIPS	LUMEN	SIZE/GW
100W	DC9-32V	CREE XT-E 5W	14000lm	22"*2.6"*2.5"/3KG
1R SERIES (MORE OPTION)	4"*20W/6"*30W/10"*50W/30"*150W/40"*200W/50"*250W			

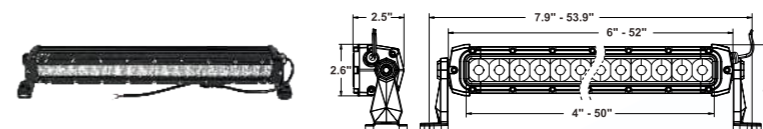

NS-WL-2R20

POWER	VOLTAGE	CHIPS	LUMEN	SIZE/GW
120W	DC9-32V	CREE XP-E 3W	16800lm	22"*23.5"*3.2"/4KG
2R SERIES (MORE OPTION)	4"*24W/6"*36W/10"*60W/30"*180W/40"*240W/50"*300W			

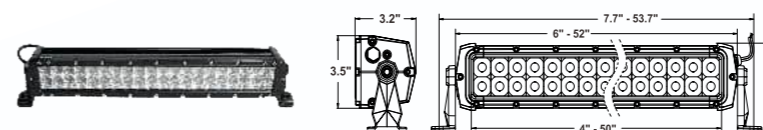

NS-LB-1R20 E1 EMARK

POWER	VOLTAGE	CHIPS	LUMEN	SIZE/GW
80W	DC9-32V	CREE XM-L 10W	13000lm	18.2"*3.2"*3.1"/3.9KG
LB SERIES (MORE OPTION)	10"*40W/26"*120W/35"*160W/30"*180W/43"*200W			

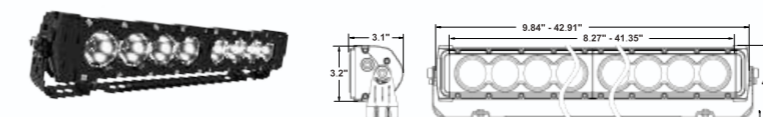



Scan code for products details



LED BMW Angel Eyes



PERFECT BRIGHT TWO RINGS
Both rings have the same brightness

SUPER BRIGHT
6500K white color (than original halogen)

ERROR FREE
Built-in resistor interference free



6063 Aluminum Extrusion

CREE Original chips ,XT-E ,XM-L

CANBUS ERROR FREE

NO NOISE

SMALLER BODY FOR 99% related BMW cars

PATENT PRODUCTS

BEFORE



AFTER



NSSC use top-rated CREE ORIGINAL CHIPS to ensure the highest output and maximum lifespan.

Upgrade Version to create brighter outer ring



NS-AE-E39-10W

POWER	MATERIALS	FEATURE	CANBUS
10W XML Chip	ONE-BODY 6063AL	NO OVER-HEAT	ERROR FREE
AVAILABLE CAR	E39 (01-03) E53(04-06) / E65(02-08) E66(02-08) / E60 (04-06) E6(04-06) E63 (04-07.6) E64 (04-07.6) / E87 (04-06) X3 (08)		



NS-AE-E90-20W

POWER	MATERIALS	FEATURE	CANBUS
2*CREE XML chips	ONE-BODY 6063AL	NO OVER-HEAT	ERROR FREE
AVAILABLE CAR	E90/91 sedan/wagon with Xenon (2005-2008 Pre-LCI)		



NS-AE-E90L-20W

POWER	MATERIALS	FEATURE	CANBUS
2*CREE XML chips	ONE-BODY 6063AL	NO OVER-HEAT	ERROR FREE
AVAILABLE CAR	E90/91 sedan/wagon with HALOGEN (2005-2008 Pre-LCI)		



NS-AE-H8-20W

POWER	MATERIALS	FEATURE	CANBUS
2*CREE XML chips	ONE-BODY 6063AL	NO OVER-HEAT	ERROR FREE
AVAILABLE CAR	E60 (2008-Current) / E82 (2007-Current) / E90, E92, E93 (2006-Current) E84 (2010-Current) / E70 / E71 (2008-Current) / E89 (2009-Current)		



NS-H8-40W-G5

POWER	MATERIALS	FEATURE	CANBUS
4*CREE XML chips	ONE-BODY 6063AL	NO OVER-HEAT	ERROR FREE
AVAILABLE CAR	E60 (2008-Current) / E82 (2007-Current) / E90, E92, E93 (2006-Current) E84 (2010-Current) / E70 / E71 (2008-Current) / E89 (2009-Current)		

DRL DAYTIME RUNNING LIGHT



Scan code for products details

E24 148R00/0736*00

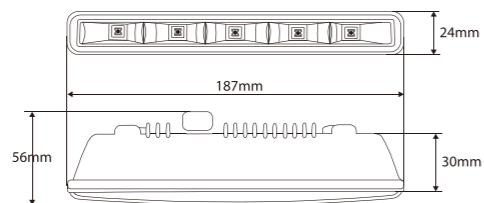

DRL 501HP

VOLTAGE	LUMEN	LED CHIPS
12/24V	1000lm	10*High Power SMD LED

E24 148R00/0743*00

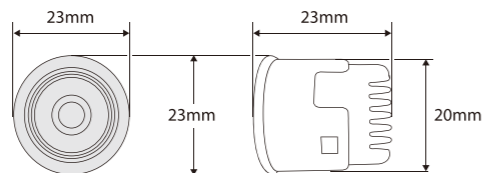

DRL 502HP Mini

VOLTAGE	LUMEN	LED CHIPS
12/24V	900lm	10*SMD LED

E24 148R00/0737*00

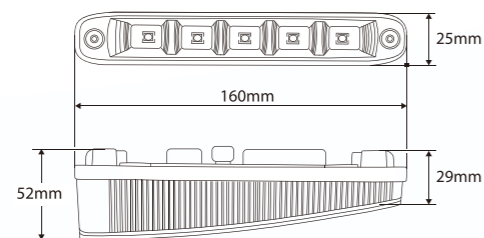

DRL 506HP

VOLTAGE	LUMEN	LED CHIPS
12/24V	1000lm	10*High Power SMD LED

E24 148R00/0738*00

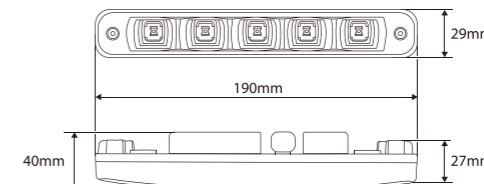

DRL 507HP

VOLTAGE	LUMEN	LED CHIPS
12/24V	1000lm	10*High Power SMD LED

E24 148R00/0740*00

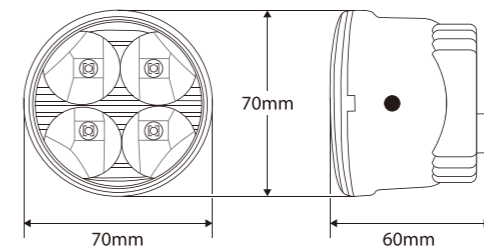

DRL 510HP

VOLTAGE	LUMEN	LED CHIPS
12/24V	800lm	8*High Power SMD LED

E24 148R00/0739*00

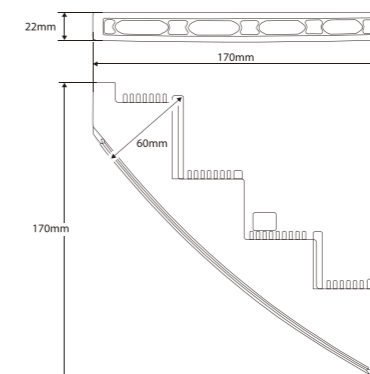

DRL 523HP Mini

VOLTAGE	LUMEN	LED CHIPS
12/24V	1200lm	8*High Power SMD LED(1.5)

E24 148R00/0741*00

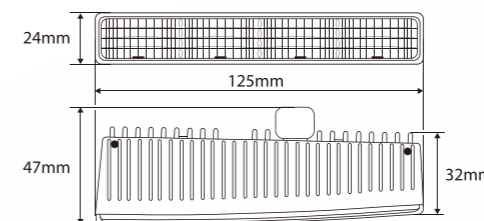
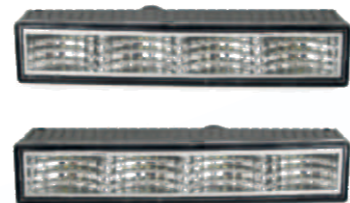

DRL 540

VOLTAGE	LUMEN	LED CHIPS
12V	800lm	8*SMD LED

E24 148R00/0742*00

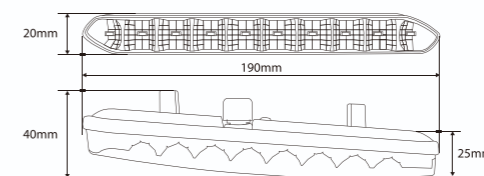

DRL 810

VOLTAGE	LUMEN	LED CHIPS
12/24V	800lm	20*SMD LED

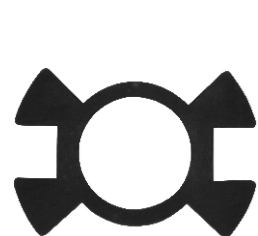

S/N: NS01

MODEL: H1

CAR MODELS:

Honda (High Beam): Odyssey ...
Geely (High Beam): Vision, Global Hawk...
Southeast (High Beam): V3, V5, Lingshi
FreeCa, DX7...
Dongfeng (High Beam): ...



S/N: NS02

MODEL: H7

CAR MODELS:

KIA: K3, K4, K5, Sorento, Sportage
Hyundai: Freescale, Coupe, Sonata
(9th gen), Santafe



S/N: NS03

MODEL: H7

CAR MODELS:

Volkswagen: Polo, new Touran, new Tiguan
MG: Maxplan
Skoda: Octavia



S/N: NS04

MODEL: H7

CAR MODELS:

Chery: RIICH 5 ...
Mercedes-Benz: C class, B class, GLA
class, GL class...
Ford: EDGE
Pentium: B50, B70, ...



S/N: NS05

MODEL: H7

CAR MODELS:

Nissan: Qashqa
Buick: Regal, LaCrosse, Excelle, Hideo, ...
Volkswagen: new Jetta, new Magotan, new Bora, ...
Mercedes-Benz: E class, ML class
Audi: A3, A4L, A6L, ...
BMW: new 5 Series, X5, ...



S/N: NS06

MODEL: H7

CAR MODELS:

New Mazda : Mazda 3, 5, 6



S/N: NS07

MODEL: H7

CAR MODELS:

Volkswagen: Golf 6

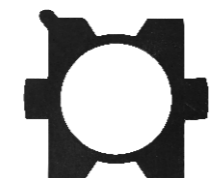

S/N: NS08

MODEL: H7

CAR MODELS:

Geely (low beam): Vision, Global Eagle
Lingyue V3, Lingzhi V5, V6,



S/N: NS09

MODEL: H7

CAR MODELS:

New Lavida, new Gran Lavida, new Lamando,
new Touran, new Tiguan, ...



S/N: NS10

MODEL: H7

CAR MODELS:

Ford: new Mondeo
Peugeot: 508, 2008, 3008, 4008, ...
Citroen: C5, DS5, DS6



S/N: NS11

MODEL: H7

CAR MODELS:

Hyundai: Mistra, new Azera, Elantra
KIA: Carens, Sonata 8

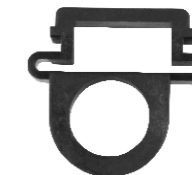

S/N: NS12

MODEL: H1

CAR MODELS:

Ford Focus, Fiesta
high beam, for copper strip braided type



S/N: NS13

MODEL: H7

CAR MODELS:

Focus low beam H7



S/N: NS14

MODEL: H7

CAR MODELS:

Ford Kuga, old Magotan
HID LED



S/N: NS15

MODEL: H7

CAR MODELS:

Fiat, Land Rover Freelander, MK3,
MK35 and 2017 new Focus



S/N: NS16

MODEL: H7

CAR MODELS:

Hyundai Mistra (2017 Low Beam)
KIA Carnival (2016 High Beam)



S/N: NS17

MODEL: H7

CAR MODELS:

Senova D50 X55 X25 X65
Mercedes-benz B ML Series
VW Touareg, Skoda Octavia classic
version Opel



S/N: NS18

MODEL: H7

CAR MODELS:

Audi A3, A4L, A6L
Buick Lacrosse, Excelle classic version,
Excelleg

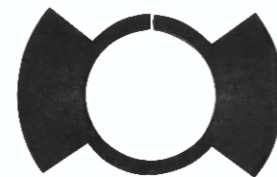

S/N: NS19

MODEL: H7

CAR MODELS:

Opel, Honda CRV, Mazda



S/N: NS20

MODEL: H7

CAR MODELS:

2017 Jetta, Golf 5